

# Data Projector

## Operating Instructions

Before operating the unit, please read this manual and supplied Quick Reference Manual thoroughly and retain it for future reference.

VPL-FH36/FH35/FH31/FH30

VPL-FX37/FX35/FX30

Not all models are available in all countries and area. Please check with your local Sony Authorized Dealer.

## HDMI

---

# Table of Contents

---

## **Overview**

Location and Function of Controls ....	3
Main Unit .....	3
Connector Panel .....	4
Remote Commander and Control Panel .....	5

---

## **Preparation**

Connecting the Projector .....	8
Connecting a Computer .....	8
Connecting a Video Equipment ...	9
Connecting an External Monitor and Audio Equipment .....	11

---

## **Projecting/Adjusting an Image**

Projecting an Image .....	12
Adjusting the Focus, Size, and Position of the Projected image .....	13
Turning Off the Power .....	18

---

## **Adjustments and Settings Using a Menu**

Using a MENU .....	19
The Picture Menu .....	20
The Screen Menu .....	22
The Function Menu .....	26
The Operation Menu .....	27
The Connection/Power Menu .....	28
The Installation Menu .....	29
The Information Menu .....	32

---

## **Network**

Using Network Features .....	33
Displaying the Control Window of the Projector with a Web Browser .....	33
Confirming the Information regarding the Projector .....	34
Operating the Projector from a Computer .....	34
Using the e-mail report Function .....	34

---

## **Others**

Indicators .....	36
Messages List .....	37
Troubleshooting .....	38
Replacing the Lamp .....	40
Cleaning the Air Filter .....	42
Removing/Attaching the Projection Lens .....	43
Removing .....	43
Attaching .....	43
Attaching the Projection Lens Adapter to the Projection Lens .....	43
Specifications .....	45
Projection Distance and Lens Shift Range .....	53
Dimensions .....	57
Index .....	60

# Location and Function of Controls

## Main Unit

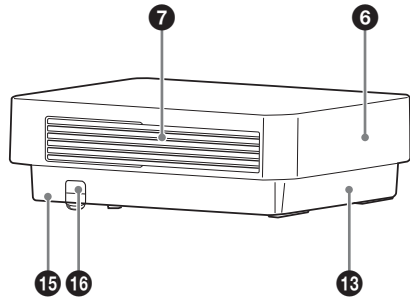
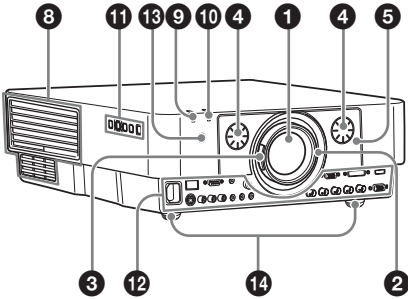

- ❶ **Lens (page 43)**
- ❷ **Focus ring (page 13)**
- ❸ **Zoom lever (page 13)**
- ❹ **Lens shift dial (page 13)**
- ❺ **Front panel (page 43)**
- ❻ **Rear panel (pages 40, 42)**
- ❼ **Ventilation holes (intake)**
- ❽ **Ventilation holes (exhaust)**

**Caution**

Do not place anything near the ventilation holes as this may cause internal heat buildup. Do not place your hand near the ventilation holes and the circumference as this may cause injury.

- ❾ **ON/STANDBY indicator (page 36)**
- ❿ **LAMP/COVER indicator (page 36)**
- ⓫ **Control panel (page 5)**

- ❹ **Connector panel (page 4)**
- ⓬ **Remote control detector**  
The remote control detectors are located at the front and rear of the projector.
- ❻ **Front feet (adjustable) (page 13)**
- ⓭ **Antitheft lock**  
Connects to an optional antitheft cable manufactured by Kensington.  
For details, visit Kensington's web site.  
<http://www.kensington.com/>
- ⓮ **Antitheft bar**  
Connects to a commercially available antitheft chain or wire.

## Connector Panel

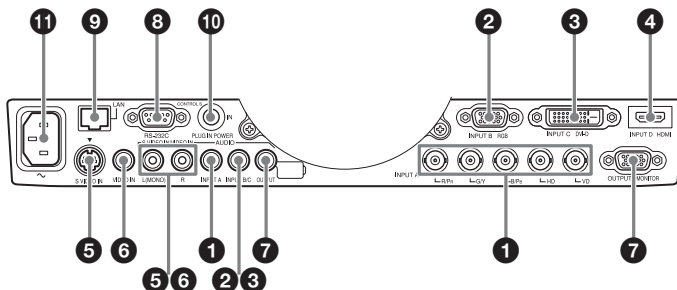

### Input (page 8)

- 1 INPUT A**  
Video: RGB/YPbPr input connector (RGB HD VD/YPbPr)  
Audio: Audio input connector (AUDIO)
- 2 INPUT B**  
Video: RGB input connector (RGB)  
Audio: Audio input connector (AUDIO)
- 3 INPUT C**  
Video: DVI-D input connector (DVI-D)  
Audio: Audio input connector (AUDIO)
- 4 INPUT D (VPL-FH36/FH35/FH31/FH30 only)**  
Video: HDMI input connector (HDMI)  
Audio: HDMI input connector (HDMI)
- 5 S VIDEO (S VIDEO IN)**  
Video: S video input connector  
Audio: Audio input connector (AUDIO L [MONO]/R)
- 6 VIDEO (VIDEO IN)**  
Video: Video input connector  
Audio: Audio input connector (AUDIO L [MONO]/R)

#### Notes

- The audio input connectors of the projector are for output to external equipment. Connect external audio equipment to output an audio (page 11).
- The audio inputs of INPUT B and INPUT C are shared. The audio inputs of S VIDEO and VIDEO also are shared.

### Output (page 11)

- 7 OUTPUT**  
Video: Monitor output connector (MONITOR)  
Audio: Audio output connector (AUDIO)

#### Note

This connector outputs the projected image or audio. The image is output as a computer signal input from the RGB input connector (INPUT A, INPUT B) or a video signal input from the YPbPr input connector (INPUT A).

### Others

- 8 RS-232C connector**  
RS-232C compatible control connector
- 9 LAN connector (page 33)**
- 10 CONTROL S input connector (DC power supply) (CONTROL S IN PLUG IN POWER)**  
Connects to the CONTROL S output connector on the supplied Remote Commander with a connecting cable (stereo mini plug (not supplied)) when using it as a wired Remote Commander. You do not need to install batteries in the Remote Commander, as the power is supplied from this connector.
- 11 AC IN (-) socket**  
Connects the supplied AC power cord.

# Remote Commander and Control Panel

## Remote Commander

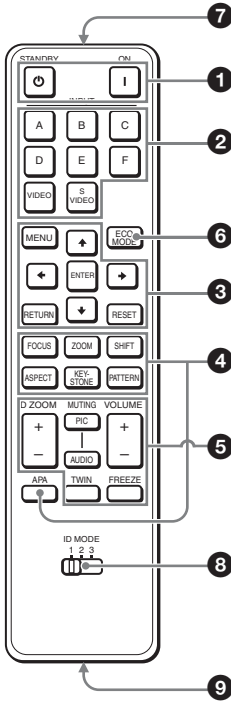

## Control Panel

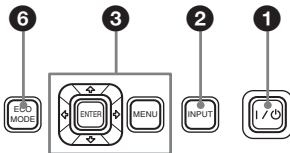

### 1 Turning on the power/Going to standby

- I** (On) key
- ⏻** (Standby) key

### 2 Selecting an input signal (page 12)

**INPUT key (main unit)**  
**Direct input select keys (Remote Commander)**

VPL-FH36/FH35/FH31/FH30: The E and F keys are not used with this projector.

VPL-FX37/FX35/FX30: The D, E, and F keys are not used with this projector.

### 3 Operating a menu (page 19)

**ENTER /▲/▼/◀/▶ (arrow) keys**  
**MENU key**  
**RETURN key**  
**RESET key**

### 4 Adjusting the image (page 13)

**FOCUS key**  
 This function is not provided in this projector.

**ZOOM key**  
 This function is not provided in this projector.

**SHIFT key**  
 This function is not provided in this projector.

**ASPECT key (pages 22, 24)**  
 Changes the aspect ratio of the projected image.

**KEYSTONE key (page 14)**

**PATTERN key (page 13)**

**APA (Auto Pixel Alignment) key\***  
 Automatically adjusts a picture to its clearest while a signal is input from a computer. You can cancel the adjustment by pressing the APA key again while adjusting.

**Note**

\* Use this key when inputting a computer signal via the RGB input connector (INPUT A, INPUT B).

## 5 Using various functions during projecting

### D ZOOM (Digital Zoom) +/- key\*1

Enlarges a portion of the image while projecting.

- 1 Press the D ZOOM + key to display the digital zoom icon on the projected image.
- 2 Press the  $\uparrow/\downarrow/\leftarrow/\rightarrow$  keys to move the digital zoom icon to the point on the image you wish to enlarge.
- 3 Press the D ZOOM + key or the D ZOOM - key repeatedly to change the enlargement ratio. The image can be enlarged up to 4 times.

Press the RESET key to restore the previous image.

### TWIN (Twin Picture) key (VPL-FH36/FH35/FH31/FH30 only)

You can project the images from two input signals on the screen as a main picture and subpicture at the same time. To switch between one and two pictures, press the TWIN key on the Remote Commander.

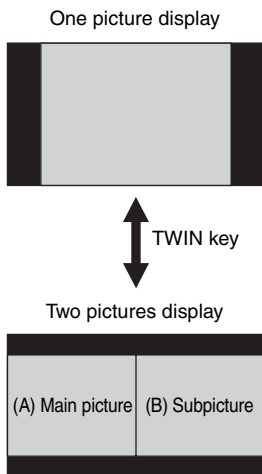

You can select the image to project to the main picture.

The subpicture is preset to display the image from INPUT B.

For details on combinations of input signals, see “Combinations of Input Signals” on page 52.

### Notes

- When displaying a two pictures, the I (On) key,  $\odot$  (standby) key, INPUT key, and MUTING (PIC) key are available.
- When “Screen Aspect” (page 29) is set to “4:3,” the two picture function is not available.
- When displaying a two pictures, the input signal icon  $\ominus$  does not appear in the input select window (page 12).
- Picture settings set for one pictures may not be reflected as two pictures.

### MUTING key

**PIC:** Cuts off the image. Press again to restore the image.

**AUDIO:** Mutes the audio output. Press again to restore the previous volume.

### VOLUME +/- key

For adjusting the volume output from the audio output connector of the projector.

### FREEZE key\*2

Pauses a projected image. Press again to restore the image.

### Notes

- \*1: Use this key when inputting a computer signal. But it may not be enabled, depending on the resolution of the input signal and when displaying a two pictures (VPL-FH36/FH35/FH31/FH30 only).
- \*2: Use this key when inputting a computer signal.

## 6 Setting the energy-saving mode easily

### ECO MODE key

“Lamp Mode,” “Power Saving Mode,” and “Standby Mode” for energy-saving can be set easily.

- 1 Press the ECO MODE key to display the ECO Mode menu.

ECO Mode Menu

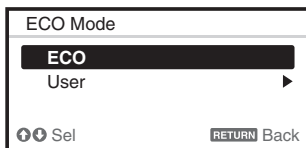

- 2 Press the  $\uparrow/\downarrow$  key or ECO MODE key to select ECO or User mode.

**ECO:** Sets each mode to the optimum energy-saving value.

Lamp Mode: Standard

Power Saving Mode: Standby

Standby Mode: Low

(go to step 6)

**User:** Sets each item of the energy-saving mode menu as you desire (go to step 3).

- 3 Select “User” then press the  $\rightarrow$  key. The setting items appear.

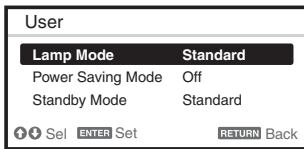

- 4 Press the  $\uparrow/\downarrow$  key to select the ECO Mode item then press the  $\rightarrow$  key or the ENTER key.

- 5 Press the  $\uparrow/\downarrow$  key to select the setting value.

- 6 Press the RETURN key to restore the previous image.

For details on ECO Mode settings, see “Lamp Mode” (page 26) on the Function menu and “Standby Mode” (page 28) and “Power Saving Mode” (page 28) on the Connection/Power menu.

You do not need to install batteries in the Remote Commander, as the power is supplied from the projector.

### About Remote Commander operation

- Direct the Remote Commander toward the remote control detector.
- The shorter the distance between the Remote Commander and the projector is, the wider the angle within which the Remote Commander can control the projector becomes.
- If there is any obstruction between the Remote Commander and the remote control detector on the projector, the projector may not be able to receive signals from the Remote Commander.

## Others

### 7 Infrared transmitter

### 8 ID MODE 1/2/3 switch (page 27)

Sets an ID mode of the Remote Commander. If you assign a different ID number to each projector when multiple projectors are used, you can control only the projector with the same ID mode as that of the Remote Commander.

### 9 CONTROL S output connector

Connects to the CONTROL S input connector on the projector with a connecting cable (stereo mini plug (not supplied)) when using the Remote Commander as a wired one.

# Connecting the Projector

## Notes

- Turn off all equipment before making any connections.
- Use the proper cables for each connection.
- Insert the cable plugs firmly; Loose connections may reduce performance of picture signals or cause a malfunction. When pulling out a cable, be sure to grip it by the plug, not the cable itself.
- For more information, refer also to the instruction manuals of the equipment you are connecting.
- Use a no-resistance audio cable.

## Connecting a Computer

Connection with a computer is explained for each input signal.

### INPUT A

For connection when there is some distance between a computer and the projector.

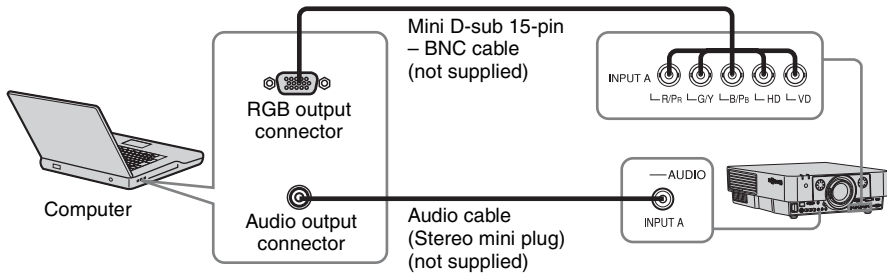

### INPUT B

For connecting a computer with an RGB output connector.

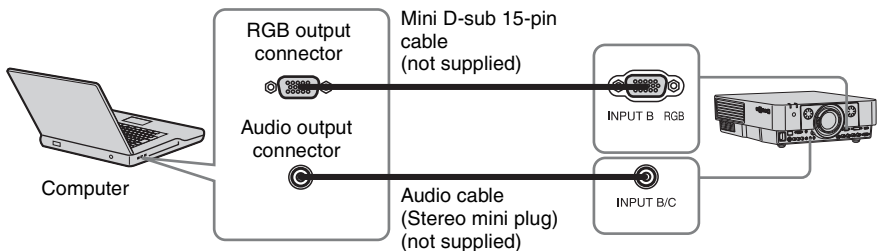

## Note

It is recommended that you set the resolution of your computer to 1920 × 1200 pixels (VPL-FH36/FH35/FH31/FH30) or 1024 × 768 pixels (VPL-FX37/FX35/FX30) for the external monitor.



## INPUT C

For connecting a computer with a DVI-D output connector.

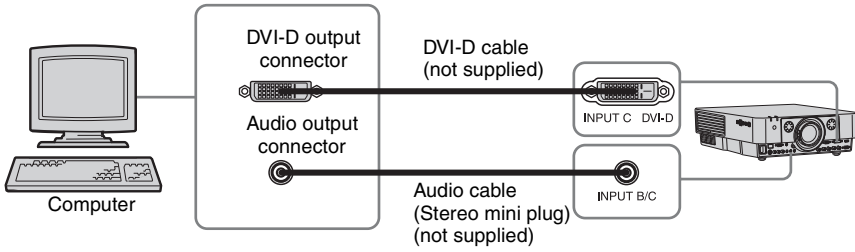

## INPUT D (VPL-FH36/FH35/FH31/FH30 only)

For connecting a computer with a HDMI output connector.

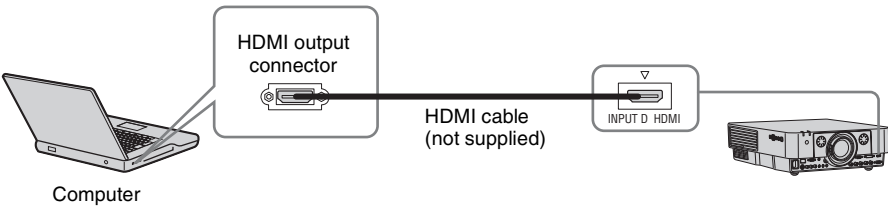

### Notes

- The HDMI connector of this projector is not compatible with DSD (Direct Stream Digital) Signal or CEC (Consumer Electronics Control) Signal.
- Be sure to use the HDMI cable with an HDMI logo.

## Connecting a Video Equipment

Connections with a VHS video deck, DVD player, or BD player are explained for each input signal.

## S VIDEO IN

For connecting video equipment with an S-video output connector.

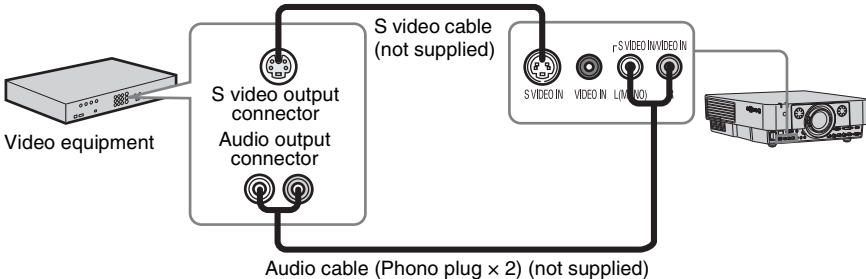

---

## VIDEO IN

For connecting video equipment with a video output connector.

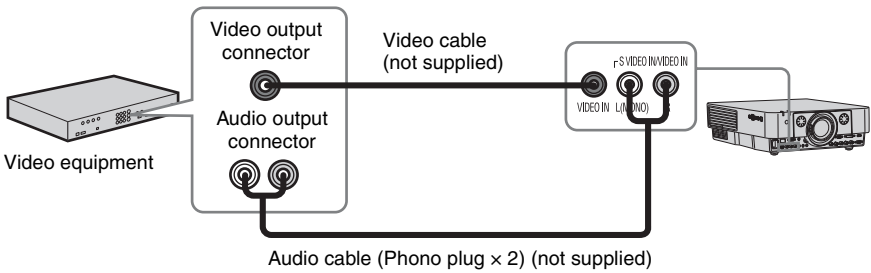

---

## INPUT A

For connection when there is some long distance between the video equipment and projector.

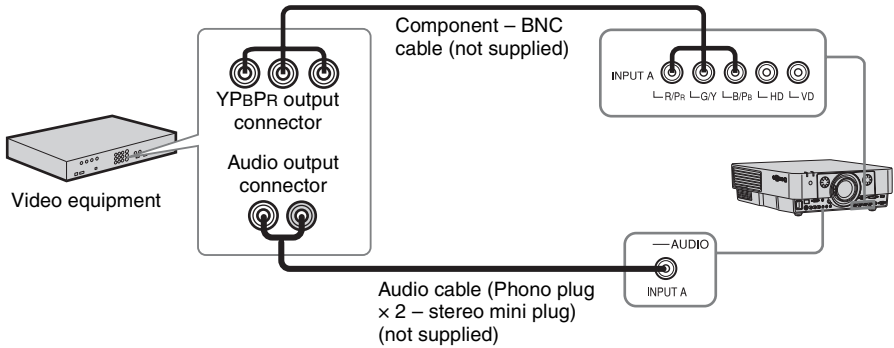

---

## INPUT D (VPL-FH36/FH35/FH31/FH30 only)

For connecting video equipment with a HDMI output connector.

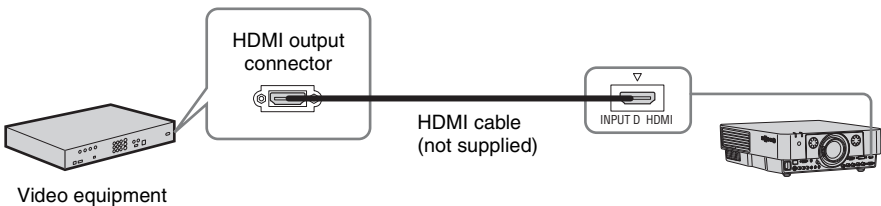

### Notes

- The HDMI connector of this projector is not compatible with DSD (Direct Stream Digital) Signal or CEC (Consumer Electronics Control) Signal.
- Be sure to use the HDMI cable with an HDMI logo.

### To attach the HDMI cable

Fix the cable to the cable tie holder at the bottom of the projector, using a commercially available cable tie, as in the illustration.  
Use a cable tie of less than 1.9 mm × 3.8 mm in thickness.

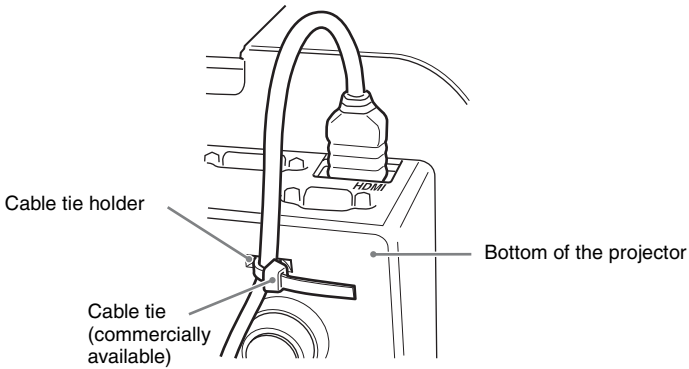

## Connecting an External Monitor and Audio Equipment

### OUTPUT

Projected images and input audio can be output to display equipment such as a monitor and audio equipment such as speakers with a built-in amplifier.

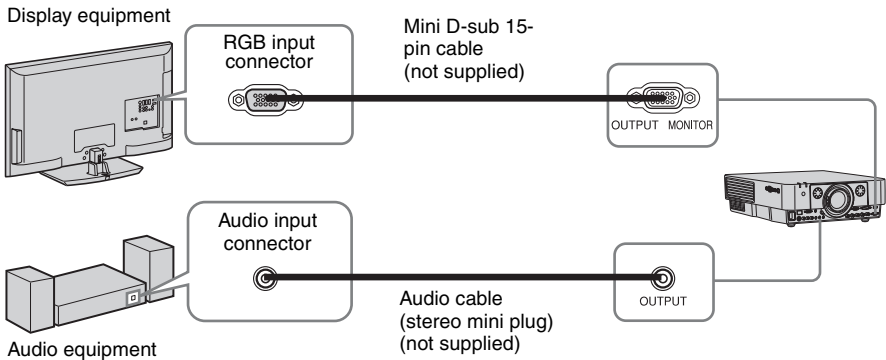



### Note

This connector outputs the projected image or audio. The image is output as a computer signal input from the RGB input connector (INPUT A, INPUT B) or a video signal input from the YPBPr input connector (INPUT A).

# Projecting an Image

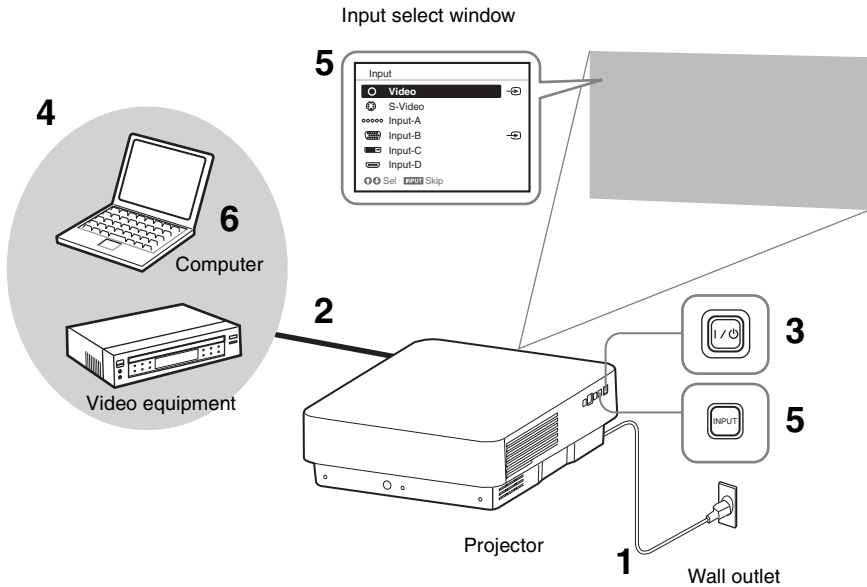
The size of a projected image depends on the distance between the projector and screen. Install the projector so that the projected image fits the screen size. For details on projection distances and projected image sizes, see “Projection Distance and Lens Shift Range” (page 53).



- 1** Plug the AC power cord into a wall outlet.
- 2** Connect all equipment to the projector (page 8).
- 3** Turn on the projector.  
Press the I/⏻ key on the main unit or the I key on the Remote Commander.
- 4** Turn on the connected equipment.
- 5** Select the input source.  
Press the INPUT key on the projector to display the input select window. Press the INPUT key repeatedly or the ⬆/⬇ key to select an image to be projected. The signal icon  appears on the right side in the input select window when a signal is input.

You can select the input source using Direct input select keys on the Remote Commander (page 5).



- 6** Switch your computer to output to external display by changing your computer's setting.  
How to switch the computer to output to the projector varies, depending on the type of computer.

(Example)

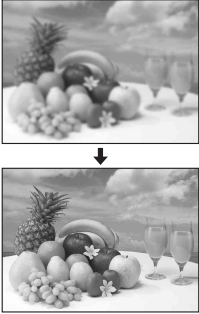

- 7** Adjust the focus, size, and position of the projected image (page 13).

## Adjusting the Focus, Size, and Position of the Projected image

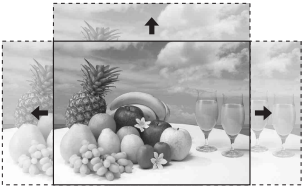
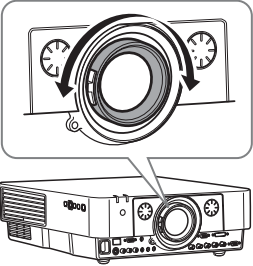
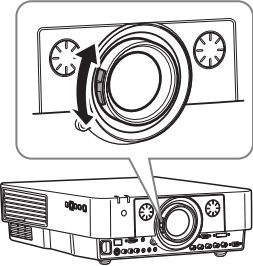
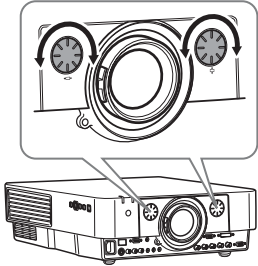
Focus	Size (Zoom)	Position (Lens shift)
		
		



### Adjusting the tilt of the projector with the front feet (adjustable)

When the projector is installed on an uneven surface and the projected position is low, you can adjust using the front feet (adjustable). To correct any trapezoidal distortion of the projected image, use the Keystone correction feature (pages 14, 29).

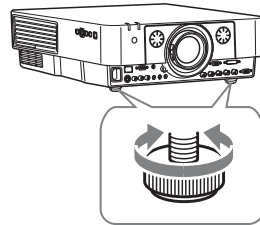

#### Notes

- Be careful not to let the projector down on your fingers.
- Do not push hard on the top of the projector with the front feet (adjustable) extended.
- Since the Keystone adjustment is an electronic correction, the image may be deteriorated.

### Displaying a pattern for adjusting an image

You can display a pattern for adjusting the projected image with the PATTERN key on the Remote Commander. Press the PATTERN key again to restore the previous image.

## Correcting for trapezoidal distortion of the projected image (Keystone adjustment)

If the screen is tilted, or you are projecting from an oblique angle, perform keystone adjustment.

- 1 Press the KEYSTONE key on the Remote Commander once or select “V Keystone” in the Installation menu to display the adjustment menu.
- 2 Adjust the value using  $\uparrow/\downarrow/\leftarrow/\rightarrow$ .  
The higher the setting, the narrower the top of the projected image. The lower the setting, the narrower the bottom of the projected image.

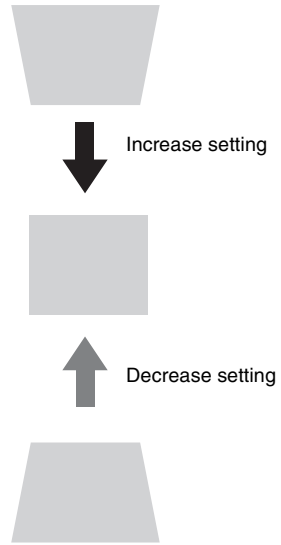

## If the projected image is trapezoidally-distorted in the lateral plane (VPL-FH36/FH31 only)

- 1 Press the KEYSTONE key on the Remote Commander twice, or select “H Keystone” in the Installation menu to display the adjustment menu.
- 2 Adjust the value using  $\uparrow/\downarrow/\leftarrow/\rightarrow$ .  
The higher the setting, the narrower the right side of the projected image. The lower the setting, the narrower the left side of the projected image.

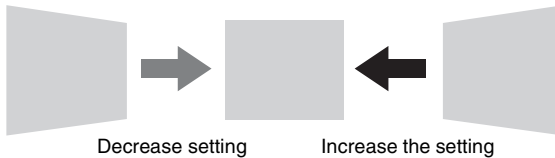

### Notes

- Since the Keystone feature is electronic, image deterioration may occur.
- Depending on the position adjusted with the lens shift feature, using the Keystone feature may change the aspect ratio of the original image, or the projected image may be distorted.
- If keystone correction is performed using the KEYSTONE key, the Warp correction feature (if enabled) will be canceled.

## Correcting image twist (Warp correction feature) (VPL-FH36/ FH31 only)

You can correct image twist with the warp correction feature.

- 1 Press the KEYSTONE key on the Remote Commander three times, or select “Warping” in the Installation menu, then select “Adjust.” The guide is displayed.

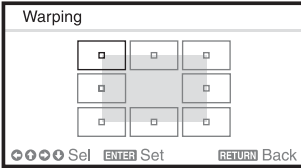

### Selecting the corner(s) of the image to be corrected

- 1 Move  using  $\uparrow/\downarrow/\leftarrow/\rightarrow$  to select the corner you want to correct.
- 2 Press the ENTER key. The cursor appears.

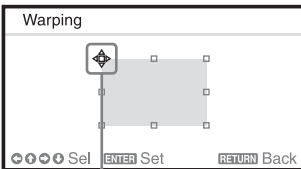

Adjust using this cursor

- 3 Adjust the position of the corner you want to correct, using  $\uparrow/\downarrow/\leftarrow/\rightarrow$ .

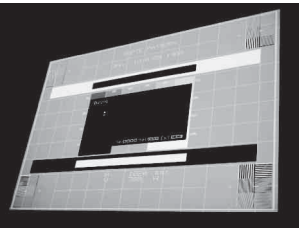

The cursor will disappear when the deflection range limit is reached.

Example of cursor display:



Adjust in all directions



Leftward, rightward or downward adjustment only

### Correcting deflection ① – left/right sides of the image

- 1 Move  using  $\uparrow/\downarrow/\leftarrow/\rightarrow$  to select the side you want to correct.

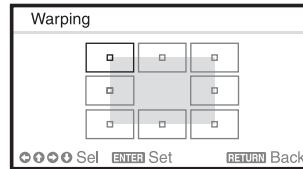

- 2 Press the ENTER key. The cursor appears.

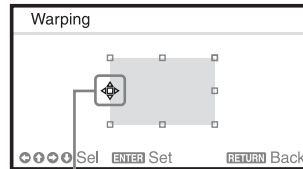

Adjust using this cursor

- 3 You can adjust the deflection of the side, using  $\uparrow/\downarrow/\leftarrow/\rightarrow$ . You can adjust the center point of deflection using  $\uparrow/\downarrow$ . For the range of deflection, use  $\leftarrow/\rightarrow$ . You can adjust the left/right side independently.



The cursor will disappear if the deflection range limit is reached.

Example of cursor display:

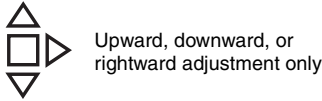
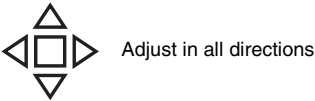

### Correcting deflection ② – top/bottom sides of the image

- 1 Move  using  $\uparrow/\downarrow/\leftarrow/\rightarrow$  to select the side you want to correct.

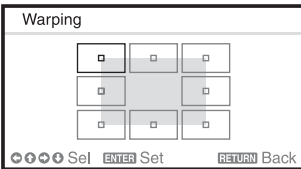

- 2 Press the ENTER key.  
The cursor appears.

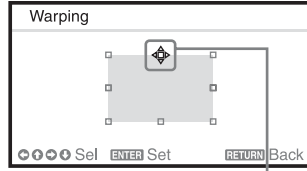

Adjust using this cursor

- 3 You can adjust the deflection of the side, using  $\uparrow/\downarrow/\leftarrow/\rightarrow$ . You can adjust the center point of deflection using  $\leftarrow/\rightarrow$ . For the range of deflection, use  $\uparrow/\downarrow$ . You can adjust the top/bottom independently.

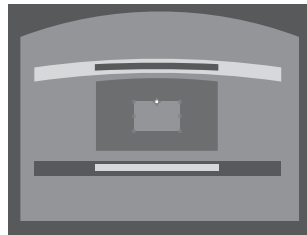
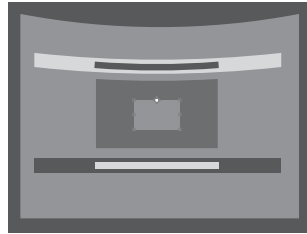

The cursor will disappear if the deflection range limit is reached.

Example of cursor display:

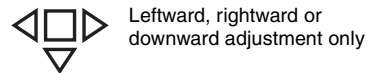
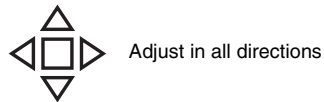



## Setting the blending function to project from multiple projectors (VPL-FH36/FH31 only)

- 1 Install the projectors.  
Input a pattern, etc., to adjust the projected positions from multiple projectors.  
Set a different ID mode for each projector (page 27).
- 2 Enable the Edge Blending function.  
Display the main menu to set “Edge Blending” to “On” in the Installation menu.
- 3 Set the position of blending.  
Choose the position (top/bottom/left/right) for blending.
- 4 Assign the blending width.  
Set the blending width according to the overlapping range for the source signal.

Assign the position and width here.

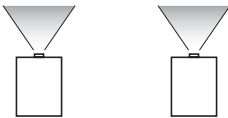
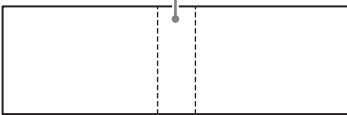

- 5 Adjust using “Zone Black Level Adj.”  
Adjust each correction zone by “Zone Black Level Adj.” for the most uniform black level between each zone.  
During this adjustment, a black image is automatically projected.
- 6 Set “Blend Gamma.”  
Select the gamma mode in which the overlapping of images is least noticeable.

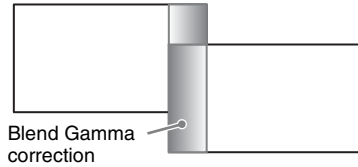

### Notes

- The procedure shown above is for general guidance. Your own installation may vary according to the situation.
- In the case of multiple projectors, use the color matching function (page 31) to adjust for differences in color and brightness. Note that more detailed adjustment for Edge Blending is possible using a PC application. For more details, consult with qualified Sony personnel.
- When multiple projectors are set up in a line, the temperature inside the projectors may increase due to exhaust vent proximity, and an error indication may result. In this case, space the projectors farther apart and/or install deflection partitioning between them. For more details, consult with qualified Sony personnel.

## Turning Off the Power

- 1** Press the I/⏻ key on the main unit or the ⏻ key on the Remote Commander. The message appears if you press the I/⏻ key on the main unit. Press it again according to the message. The fan continues to run for a while to reduce internal heat.
- 2** Unplug the AC power cord from the wall outlet. You may unplug the AC power cord before the fan stops.

### Note

To move the projector just after turning it off, be sure to wait until the fan stops before unplugging the AC power cord. Unplugging the AC power cord before the fan stops may cause a malfunction.

---

### To erase the confirmation message

The message disappears if you press any key other than the I/⏻ key on the main unit or ⏻ key on the Remote Commander, or if you do not press any key for a while.

---

### To turn off the power with the key on the main unit without a confirmation message being displayed

Hold the I/⏻ key on the main unit pressed for a few seconds.

# Using a MENU

**Note**

The menu displays used for the explanation below may be different depending on the model you are using.

- 1 Press the MENU key to display the menu.
- 2 Select the setting menu.  
Use the **▲** or **▼** key to select the setting menu then press **▶** or ENTER key.

Setting menu

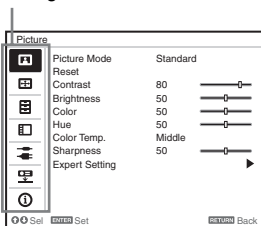

- 3 Select the setting item.  
Use the **▲** or **▼** key to select the setting menu then press **▶** or ENTER key.  
To return to the selection screen of the setting menu, press the **◀** key or the RETURN key.

Setting items

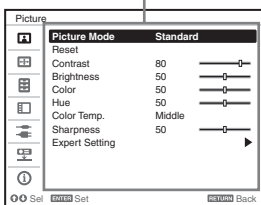

- 4 Make the setting or adjustment for the selected item.

Menu operation differs depending on the setting item. If the next menu window is displayed, select the item according to the operations in step 3 and then press the ENTER key to register the setting.

To return to the selection screen of the setting items, press the **◀** key or the

RETURN key. Also, to reset the setting value of an item to its factory preset value, press the RESET key during setting or adjusting.

**Using a pop-up menu**

Press the **▲/▼/◀/▶** key to select an item. Press the ENTER key to register the setting. The previous screen is restored.

Selecting items

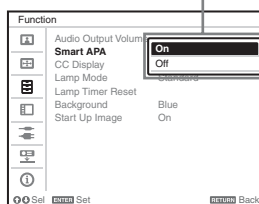

**Using the setting menu**

Press the **▲** or **▼** key to select the item. Press the ENTER key to register the setting. The previous screen is restored.

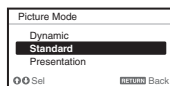

**Using the adjustment menu**

To increase the number, press the **▲** or **▶** key and to decrease the number, press the **▼** or **◀** key. Press the ENTER key to register the setting. The previous screen is restored.



- 5 Press the MENU key to clear the menu.

The menu disappears automatically if no key is pressed for a while.

# The Picture Menu

For adjusting the picture for each input signal.

Setting items	Description
Picture Mode	<b>Dynamic:</b> Emphasizes the contrast to produce a “dynamic” picture. <b>Standard:</b> Makes the picture be natural and well balanced. <b>Presentation</b> <sup>*1</sup> : Makes the picture bright to suit for a presentation.
Reset	The picture settings are initialized to their factory preset values. However, “Picture Mode” and “Custom1,” “Custom2,” and “Custom3” of “Color Temp.” do not return to the factory preset values.
Contrast	The higher the setting, the greater the contrast. The lower the setting, the lower the contrast.
Brightness	The higher the setting, the brighter the picture. The lower the setting, the darker the picture.
Color <sup>*2 *4</sup>	The higher the setting, the greater the intensity. The lower the setting, the lower the intensity.
Hue <sup>*2 *4 *5</sup>	The higher the setting, the more greenish the picture becomes. The lower the setting, the more reddish the picture becomes.
Color Temp. <sup>*3</sup>	<b>High/Middle/Low:</b> The higher the temperature, the more bluish the picture. The lower the temperature, the more reddish the picture. <b>Custom1/ Custom2/ Custom3:</b> An adjusted color temperature setting can be stored for each item. The factory settings are Custom1: High, Custom2: Middle, Custom3: Low.
Sharpness <sup>*6</sup>	The higher the setting, the sharper the picture. The lower the setting, the softer the picture.
Expert Setting	
Film Mode <sup>*2 *7</sup>	<b>Auto:</b> Precisely reproduces the image from a film source to suit the original film source. Normally, select this option. <b>Off:</b> Select this option if the images are rough around the edges when “Auto” is selected.
Black Level Adj. (Adjust) <sup>*2</sup>	<b>High/Low/Off:</b> Emphasizes dark portions of the projected image to suit your taste.
Gamma Mode <sup>*1</sup>	<b>Graphics1:</b> Improves the correction of halftones to give a brighter image. This can be useful when projecting colored images, such as photos, in a bright location. <b>Graphics2:</b> Improves the reproduction of halftones. This reproduces colored images, such as photos, in more natural tones. <b>Text:</b> Contrasts black and white. Suitable for images that contain lots of text. <b>DICOM GSDF Sim.</b> <sup>*8</sup> : Gamma setting is in accordance with the Grayscale Standard Display Function (GSDF) of the Digital Imaging and Communications in Medicine (DICOM) standards.

## Notes

\*1: When a computer signal is input, this option is available.

\*2: When a video signal is input, this option is available.

\*3: When “Picture Mode” is set to the item other than “Presentation,” this option is available.

\*4: When a B & W signal is input, this option is not available.

- \*5: When an analog TV signal is input, this option may not be available, depending on the color system.
- \*6: When a video signal is input, this option is available (VPL-FX37/FX35/FX30).
- \*7: When a progressive signal is input, this option is not available.
- \*8: Available when a computer signal is input from the DVI-D input connector (INPUT C) and HDMI input connector (INPUT D). This projector is not to be used as a device for medical diagnosis (VPL-FH36/FH35/FH31/FH30).

# The Screen Menu

For adjusting the size, position, and aspect ratio of the projected image for each input signal.

Setting items	Description
Aspect <sup>*1</sup>	Changes the aspect ratio of the projected image. (page 24).
When the computer signal is input	<p><b>Full1:</b> Displays the image to fit the maximum projected image size without changing the aspect ratio of the input signal.</p> <p><b>Full2:</b> Displays the image to fit the maximum projected image size.</p> <p><b>Normal:</b> Displays the image on the center point of the projected image without changing the resolution of the input signal or enlarging the image.</p>
When the video signal is input	<p><b>4:3:</b> Displays the image to fit the maximum projected image size with an aspect ratio fixed to 4:3.</p> <p><b>16:9:</b> Displays the image to fit the maximum projected image size with an aspect ratio fixed to 16:9.</p> <p><b>Full<sup>*2</sup>:</b> Displays the image to fit the maximum projected image size.</p> <p><b>Zoom:</b> Display the center point of the projected image to zoom.</p>
V Center <sup>*2 *3</sup>	Adjust the whole projected image by moving up and down on the screen. As the selected number increases, the screen moves up, and as the selected number decreases, the projected image moves down.
Vertical Size <sup>*2 *3</sup>	Reduces or enlarges the image vertically. The projected image is enlarged as the setting increases and reduced as the setting decreases. If the subtitle of a movie, etc. cannot be seen, use this together with “V Center.”
Over Scan <sup>*3</sup>	<b>On/Off:</b> Hides the outline of the image when set to “On.” Select “On” if noise appears along the edge of the image.
Adjust Signal <sup>*6</sup>	Adjusts the image of a computer signal. Use this item if the edge of the image is cut and reception is bad.
APA <sup>*4 *5</sup>	Automatically adjusts the projected image to an optimum quality when you press the ENTER key.
Phase <sup>*4</sup>	Adjusts the dot phase of the display pixel and the input signal. Set to the value where looks clearest.
Pitch <sup>*4</sup>	The higher the setting, the wider the horizontal image elements (pitch). The lower the setting, the narrower the horizontal image elements (pitch).
Shift <sup>*6</sup>	<p><b>H:</b> The higher the setting, the farther right the image is projected on the screen. The lower the setting, the image farther left.</p> <p><b>V:</b> The higher the setting, the farther up the image is projected on the screen. The lower the setting, the image farther down.</p>

## Notes

\*1: • Note that if the projector is used for profit or for public viewing, modifying the original picture by switching to the aspect mode may constitute an infringement of the rights of authors or producers, which are legally protected.



- Depending on the input signal, setting items for aspect ratio or some other setting items cannot be set in some cases, or changing the aspect ratio setting may have no effect.
- A part of the image may be displayed in black, depending on the setting item.

\*2: Available for VPL-FH36/FH35/FH31/FH30 only.

- \*3: Available when a video signal is input from the YPbPr input connector (INPUT A), DVI-D input connector, and HDMI input connector.
- \*4: Available when a computer signal is input from the RGB input connector (INPUT A, INPUT B).
- \*5: If the projected image includes large amount of black portion around it, the APA function will not work properly and a part of the image may not be displayed on the screen and also optimum image cannot be obtained, depending on the type of input signal. In this case, adjust the “Phase,” “Pitch,” and “Shift” items manually.
- \*6: Available when a computer signal is input from the RGB input connector (INPUT A, INPUT B) or a video signal is input from the YPbPr input connector (INPUT A). This option is available only when “Aspect” is set to “Zoom.”

# Aspect

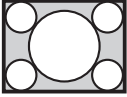
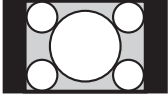
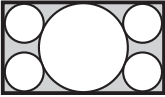
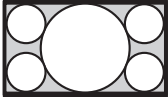
## VPL-FH36/FH35/FH31/FH30

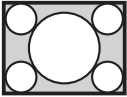
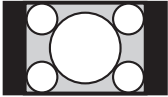
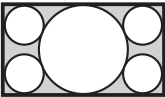
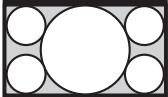
	Input signal	Recommended setting value and projected image
Computer signal	(4:3) 	(Full1) <sup>*1 *2</sup> 
	(16:9) 	(Full1) <sup>*1 *2</sup> 
	(16:10) 	(Full1) <sup>*1</sup> 
Video signal	(4:3) 	(4:3) <sup>*3 *5</sup> 
	(16:9) 	(16:9) <sup>*4 *5</sup> 

\*1: If you select “Normal,” the image is projected in the same resolution as the input signal without changing the aspect ratio of the original image.



\*2: If you select “Full2,” the image is projected to fit the projected image size, regardless of the aspect ratio of the image.



\*3: Depending on the input signal, the projected image may be projected as illustrated below. In this a case, select “16:9.”



\*4: Depending on the input signal, the image may be projected as illustrated below. In this a case, select “Zoom.”



\*5: If you select “Full,” the image is projected to fit the projected image size, regardless of the aspect ratio of the image.



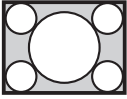
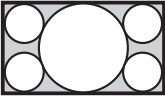
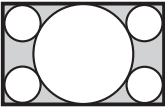
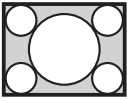
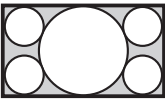

	Input signal	Recommended setting value and projected image
Computer signal	(4:3)	(Full1) <sup>*1</sup> 
	(16:9)	(Full1) <sup>*1 *2</sup> 
	(16:10)	(Full1) <sup>*1 *2</sup> 
Video signal	(4:3)	(4:3) <sup>*3</sup> 
	(16:9)	(16:9) <sup>*4</sup> 

\*1: If you select “Normal,” the image is projected in the same resolution as the input signal without changing the aspect ratio of the original image.



\*2: If you select “Full2,” the image is projected to fit the projected image size, regardless of the aspect ratio of the image.



\*3: Depending on the input signal, the projected image may be projected as illustrated below. In this a case, select “16:9.”



\*4: Depending on the input signal, the image may be projected as illustrated below. In this a case, select “Zoom.”



## The Function Menu

The Function menu is used for setting various functions of the projector.

Setting items	Description
Audio Output Vol.	The higher the setting, the higher an audio level output from the audio output connector. The lower the setting, the lower the audio level.
Smart APA	<b>On/Off:</b> When set to “On,” executes APA automatically when a signal is input. <sup>*1</sup>
CC Display	<b>CC1/CC2/CC3/CC4/Text1/Text2/Text3/Text4:</b> Select the closed caption service (Captions or Text). <b>Off:</b> Closed caption does not appear.
Lamp Mode	<b>High/Standard:</b> When set to “High,” the image becomes brighter, and power consumption becomes higher.
Lamp Timer Reset	When replacing the lamps, resets the lamp timer (page 41).
Background <sup>*2</sup>	<b>Blue/Black/Image:</b> Sets the background for when there is no input signal. When set to “Image,” the Start Up Image is displayed.
Start Up Image	<b>On/Off:</b> When set to “On,” the Start Up Image is displayed on the screen upon startup of the projector.

### Notes

\*1: Executes APA when a computer signal is input via the RGB input connector (INPUT A, INPUT B).

\*2: When using the Twin Picture display mode and there is no input signal, the background will be black if you set this item to “Image” (VPL-FH36/FH35/FH31/FH30).

# The Operation Menu

The Operation Menu is used for setting for the operations by using the menu or the Remote Commander.

Setting items	Description
Language	Selects the language used in the menu and on-screen displays.
Menu Position <sup>*1</sup>	<b>Bottom Left/Center:</b> For selecting the position of the menu displayed on the projected image.
Status	<b>On:</b> All on-screen statuses are enabled. <b>Off:</b> Turn off the on-screen displays except for the menus, message when turning off the power, and warning messages.
IR Receiver	<b>Front &amp; Rear/Front/Rear:</b> Selects the remote control detectors (IR Receiver) on the front and rear of the projector.
ID Mode	<b>All/1/2/3:</b> Assigns an ID number to the projector. When set to "All," you can control the projector with the Remote Commander independently of the assigned ID Mode. Refer also to "ID MODE 1/2/3 switch" of the Remote Commander on page 7.
Security Lock <sup>*2</sup>	<b>On/Off:</b> This function enables restriction of the projector to authorized users by password. The setting procedures for security locking are as follows: <ol style="list-style-type: none"><li>1 Select "On" then press the ENTER key to display the setting menu.</li><li>2 Input the password with the MENU, <math>\blacktriangle</math>/<math>\blacktriangledown</math>/<math>\blacktriangleleft</math>/<math>\blacktriangleright</math>, and ENTER keys. (The default password setting is "ENTER, ENTER, ENTER, ENTER.")</li><li>3 Input a new password with the MENU, <math>\blacktriangle</math>/<math>\blacktriangledown</math>/<math>\blacktriangleleft</math>/<math>\blacktriangleright</math>, and ENTER keys.</li><li>4 Enter the password again to confirm.</li></ol> Enter the password when you turn on the projector after disconnecting and reconnecting the AC power cord. When it is set to "Off," you can cancel the security lock. You are required to input the password again. If you fail to enter the correct password after three consecutive times, the projector cannot be used. In this case, press the I/O key to go Standby mode then turn on the power again.
Panel Key Lock	<b>On/Off:</b> When set to "On," locks all the control panel keys of the projector. However, you can enable operation by performing the following even when "Panel Key Lock" is set to "On." <ul style="list-style-type: none"><li>• Press and hold the I/O key for approximately 10 seconds during Standby mode. → The projector turns on.</li><li>• Press and hold the MENU key for approximately 10 seconds during power on. → "Panel Key Lock" is set to "Off" and enables operation of all control panel keys on the projector.</li></ul>

## Notes

\*1: Available for VPL-FH36/FH35/FH31/FH30 only

\*2: You will not be able to use the projector if you forget your password. If you call qualified Sony personnel because you have forgotten the password, you will be asked to verify the projector's serial number and your identity. (This process may differ in other countries/regions.) Once your identity has been confirmed, we will provide you with the password.

# The Connection/Power Menu

The Connection/Power menu is used for setting for the connections and power.

Setting items	Description
Network Setting	
IP Address Setup	<b>Auto (DHCP):</b> The IP address is assigned automatically from the DHCP server such as a router. <b>Manual:</b> To specify the IP Address manually.
IP Address/ Subnet Mask/ Default Gateway/Primary DNS/Secondary DNS	When “Manual” is selected for “IP Address Setup,” select the item with the ◀ or ▶ key and input the value with ▲ or ▼ key. When all items are entered, select “Apply” then press the ENTER key. The entered settings will be registered.
Input-A Signal Sel.	<b>Auto/Computer/Video GBR/Component:</b> When set to “Auto,” selects the type of video signal input automatically when “Input-A” is selected with the INPUT key.* <sup>1</sup>
Color System	<b>Auto/NTSC3.58/PAL/SECAM/NTSC4.43/PAL-M/PAL-N:</b> When set to “Auto,” selects the color system automatically when “S Video” or “Video” is selected with the INPUT key.* <sup>1</sup>
Standby Mode* <sup>2</sup>	<b>Standard/Low:</b> When set to “Low,” lowers power consumption in Standby mode.
Power Saving Mode	<b>Lamp Cutoff:</b> The lamp turns off automatically and power consumption is reduced if no signal is input for 10 minutes. The lamp lights again when a signal is input or any key is pressed. In Lamp Cutoff, the ON/STANDBY indicator lights in orange (page 36). <b>Standby:</b> The power will be turned off automatically and the projector goes to Standby mode if no signal is input for 10 minutes. <b>Off:</b> The Power Saving Mode is released.
Direct Power On	<b>On/Off:</b> When set to “On,” you can turn the power on without going to Standby mode when the AC power cord is connected to a wall outlet. You can also unplug the AC power cord without going to Standby mode when you turn off the projector. You may unplug the AC power cord without going to Standby mode.





## Notes

- \*1: The image may not be adjusted properly depending on the type of input signal. In such a case, adjust it manually to suit to the connected equipment.
- \*2: When “Standby Mode” is set to “Low,” the network and network control function cannot be operated while the projector is in standby mode.

# The Installation Menu

The Installation menu is used for installing the projector.

## VPL-FH35/FH30/VPL-FX37/FX35/FX30





Setting items	Description
Image Flip	<b>HV/H/V/Off:</b> Flips the projected image horizontally and/or vertically according to the installation method.
Installation Attitude	<b>Right Side Up/Upside Down:</b> Change the cooling setting to suit to the installation attitude. Continuing to use the wrong setting may affect component reliability.
High Altitude Mode <sup>*1</sup>	<b>On/Off:</b> Set to “On” when using the projector at an altitude of 1,500 m or higher. Continuing to use the wrong setting may affect component reliability.
Screen Aspect <sup>*2</sup>	<b>16:10/16:9/4:3:</b> For switching the display area to suit to the screen.
V Keystone <sup>*3 *4</sup>	The higher the setting, narrower the top of the projected image. The lower the setting, the narrower the bottom.
Panel Alignment <sup>*2 *5</sup>	This feature allows you to adjust the gaps in the color of characters or the picture. When set to “On,” “Adjust Color” and “Pattern Color” can be assigned and adjusted. <b>Adjust Item:</b> Selects how to make adjustments from below. <b>Shift:</b> Shifts the whole picture and makes adjustments. <b>Zone:</b> Selects the desired range and makes adjustments. <b>Adjust Color:</b> Assigns the desired color to adjust the gaps in color. Select “R” (Red) or “B” (Blue) to make adjustments based on “G” (Green). <b>Pattern Color:</b> Select “R/G” (Red and Green) or “R/G/B” (White, all colors) when “Adjust Color” is “R” (Red). Select “B/G” (Blue and Green) or “R/G/B” (White, all colors) when the “Adjust Color” is “B” (Blue). <b>Adjust:</b> The shift adjustment and zone adjustment of the color selected in “Adjust Color” can be made with  /  /  /  buttons. <b>Reset:</b> The panel alignment settings are initialized to their factory preset values.
Color Matching <sup>*2 *6</sup>	<b>Adjust/Reset:</b> For correcting the brightness and color of the whole projected image manually from the signal level in six steps.

### Notes

- \*1: Do not use the projector at an altitude of 2,700 m or higher.
- \*2: Available for VPL-FH35/FH30 only
- \*3: Depending on the position adjusted with the lens shift feature, the aspect ratio of the image may change from the original or projected image may be distorted with Keystone adjustment.
- \*4: Since the Keystone adjustment is an electronic correction, the image may be deteriorated.
- \*5: Depending on the adjustment value of “Panel Alignment,” the color and aspect ratio may be changed.
- \*6: The brightness and color of the projected image may not match completely, even after you adjust “Brightness” and “Color.”

## VPL-FH36/FH31

Setting items	Description
Edge Blending	<b>On/Off:</b> When set to “On,” the Edge Blending function is enabled. Set to “Off” when you do not project using multiple projectors.
Blending Range	Sets the edge blending width. After selecting the blending position, a marker will be displayed. <b>Top:</b> Adjusts the top width of the screen. <b>Bottom:</b> Adjusts the bottom width of the screen. <b>Left:</b> Adjusts the left width of the screen. <b>Right:</b> Adjusts the right width of the screen.
Zone Black Level Adj. <sup>*1</sup> <sup>*2</sup>	Adjust so that the overlapped part is not noticeably bright when a dark image is displayed. Select the correction zone “Adjust Zone 1” through “Adjust Zone 9,” and set the adjustment values.
Blend Gamma	Sets the mode of the gamma curve of the overlapped area. <b>Mode 1:</b> Provides a gentle gamma correction curve. <b>Mode 2:</b> ↑ <b>Mode 3:</b> ↓ <b>Mode 4:</b> ↓ <b>Mode 5:</b> Provides a sharp gamma correction curve.
Reset	Resets the adjusted values to their default values.
Screen Fitting <sup>*3</sup>	<b>HV Keystone/Warping:</b> You can choose the way to correct image twist.
V Keystone <sup>*4</sup> <sup>*5</sup>	This is displayed when “HV Keystone” is selected in “Screen Fitting.” The higher the setting, the narrower the top of the projected image. The lower the setting, the narrower the bottom of the projected image.
H Keystone <sup>*4</sup> <sup>*5</sup>	This is displayed when “HV Keystone” is selected in “Screen Fitting.” The higher the setting, the narrower the right side of the projected image. The lower the setting, the narrower the left side of the projected image.
Warping <sup>*5</sup>	This is displayed when “Warping” is selected in “Screen Fitting.” <b>Adjust:</b> Corrects image twist. <b>Reset:</b> Resets the adjusted values to their default values.
Image Flip	<b>HV/H/V/Off:</b> Flips the projected image horizontally and/or vertically according to the installation method.
Installation Attitude	<b>Right Side Up/Upside Down:</b> Change the cooling setting to suit to the installation attitude. Continuing to use the wrong setting may affect component reliability.
High Altitude Mode <sup>*6</sup>	<b>On/Off:</b> Set to “On” when using the projector at an altitude of 1,500 m or higher. Continuing to use the wrong setting may affect component reliability.
Screen Aspect	<b>16:10/16:9/4:3:</b> For switching the display area to suit to the screen.

Setting items	Description
Panel Alignment <sup>*7</sup>	<p>This feature allows you to adjust the gaps in the color of characters or the picture.</p> <p>When set to “On,” “Adjust Color” and “Pattern Color” can be assigned and adjusted.</p> <p><b>Adjust Item:</b> Selects how to make adjustments from below.</p> <p><b>Shift:</b> Shifts the whole picture and makes adjustments.</p> <p><b>Zone:</b> Selects the desired range and makes adjustments.</p> <p><b>Adjust Color:</b> Assigns the desired color to adjust the gaps in color. Select “R” (Red) or “B” (Blue) to make adjustments based on “G” (Green).</p> <p><b>Pattern Color:</b> Select “R/G” (Red and Green) or “R/G/B” (White, all colors) when “Adjust Color” is “R” (Red). Select “B/G” (Blue and Green) or “R/G/B” (White, all colors) when the “Adjust Color” is “B” (Blue).</p> <p><b>Adjust:</b> The shift adjustment and zone adjustment of the color selected in “Adjust Color” can be made with /// buttons.</p> <p><b>Reset:</b> The panel alignment settings are initialized to their factory preset values.</p>
Color Matching <sup>*8</sup>	<p><b>Adjust/Reset:</b> For correcting the brightness and color of the whole projected image manually from the signal level in six steps.</p>

### Notes

- \*1: You cannot adjust anything other than the targeted adjustment zones in “Zone Black Level Adj.”
- \*2: When selecting the correction zone of “Zone Black Level Adj.,” the targeted correction zone flashes twice.
- \*3: When “Edge Blending” is set to “On,” “Screen Fitting” (HV Keystone/Warping) is not displayed.
- \*4: Depending on the position adjusted with the lens shift feature, the aspect ratio of the image may change from the original or projected image may be distorted with Keystone adjustment.
- \*5: Since the HV Keystone/Warping adjustment is an electronic correction, the image may deteriorate.
- \*6: Do not use the projector at an altitude of 2,700 m or higher.
- \*7: Depending on the adjustment value of “Panel Alignment,” the color and aspect ratio may be changed.
- \*8: The brightness and color of the projected image may not match completely, even after you adjust “Brightness” and “Color.”

---

## **i** The Information Menu

The Information menu enables you to confirm various information on the projector, such as the total usage hours of a lamp.

<b>Items</b>	<b>Description</b>
Model Name	Displays the model name.
Serial No.	Displays the serial number.
fH / fV (horizontal frequency/vertical frequency)*1	Displays the horizontal frequency/vertical frequency/signal type of the current input signal.
Lamp Timer	Indicates the total usage time of a lamp.

### **Note**

\*1: These items may not be displayed depending on the input signal.



# Using Network Features

Connection to the network allows you to operate the following features:

- Checking the current status of the projector via a Web browser.
- Remotely controlling the projector via a Web browser.
- Receiving the e-mail report for the projector.
- Making the network settings for the projector.
- Supports network monitoring and control protocol (Advertisement, PJ Talk, PJ Link, SNMP, AMX DDDP [Dynamic Device Discovery Protocol]).

## Notes

- The menu displays used for the explanation below may be different depending on the model you are using.
- Supported Web browsers are Internet Explorer 6/7/8/9.
- The menu displays only English.
- If the browser of your computer is set to [Use a proxy server] when you have access to the projector from your computer, click the check mark to set accessing without using a proxy server.

## Displaying the Control Window of the Projector with a Web Browser

**1** Connect the LAN cable.

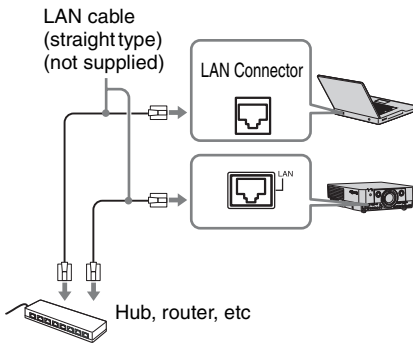

You can confirm the IP address of the projector under “Network Setting” on the Connection/Power menu (page 28).

The following window appears in the Web browser:

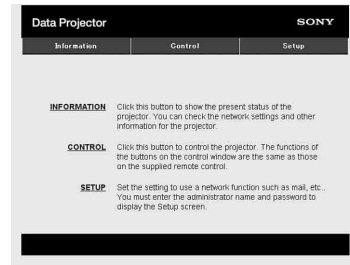

**2** Set the network settings for the projector using “Network Setting” on the Connection/Power menu (page 28).

**3** Start a web browser on the computer, enter the following in the address field, then press the Enter key on your computer.

http://xxx.xxx.xxx.xxx  
(xxx.xxx.xxx.xxx: IP address for the projector)

Once you make the network settings, you can open the Control window only by performing step **3** of this procedure.

## How to operate the Control window

### Switching the page

Click one of the Page Switching buttons to display the desired setting page.

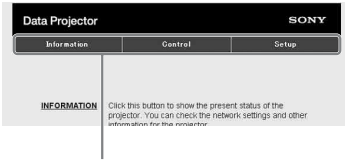

Page Switching buttons

### Setting the access limitation

You can limit a user for accessing any particular page.

**Administrator:** Allowed access to all pages

**User:** Allowed access to all pages except the Setup page

Set under [Password] of the Setup page. When you access the Setup page for the first time, enter “root” for user name and enter nothing for password. The name of the administrator is preset to “root.”

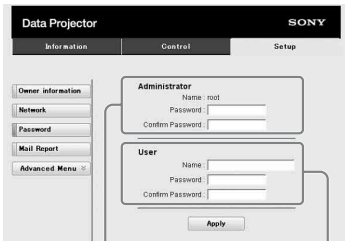

Entry area for [Administrator]

Entry area for [User]

When you change the password, input a new password after deleting the password (\*\*\*\*\*) that was set.

#### Note

If you forget your password, consult with qualified Sony personnel.

## Confirming the Information regarding the Projector

You can confirm the current settings for the projector on the Information page.



Information area

## Operating the Projector from a Computer

You can control the projector from the computer on the Control page.

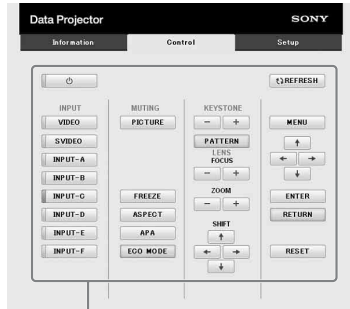

Operation area

The functions of the keys shown in the operation area are the same as those of the keys on the supplied Remote Commander.

## Using the e-mail report Function

Set the e-mail report function on the Setup page.

Entered values will not be applied unless you click on [Apply].

- 1 Click on [Owner information] to enter the owner information recorded in the e-mail report.

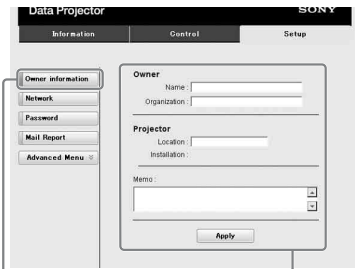

Owner information button

1

- 2 Set the timing of the e-mail report. Click on [Mail Report] to open the Mail Report page.

**Lamp Reminder (Lamp1):** Set the timing for lamp replacement. To reset Lamp Reminder, execute “Lamp Timer Reset” on the projector (page 26).

**Maintenance Reminder:** Set the timing for maintenance. To reset Maintenance Reminder, check the RESET check box and then click on [Apply].

Mail Report button

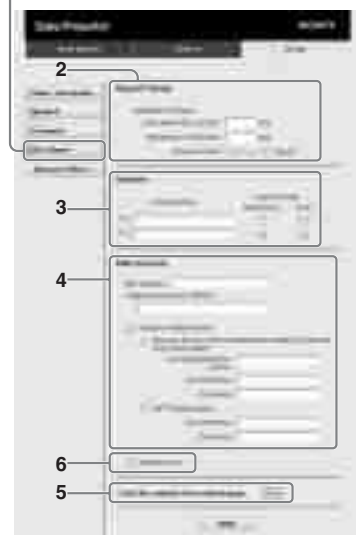

- 3 Enter the outgoing e-mail address in the Email Address box then check the Report Timing check box of the e-mail report to be sent.

- 4 Set the mail account for sending e-mail reports.

**Mail Address:** Enter the e-mail address.  
**Outgoing Mail Server (SMTP):** Enter the address of outgoing mail server (SMTP).

**Required Authentication:** Check this check box if authentication is required for sending e-mail.

**Requires the use of POP**

**Authentication before send email**

**(POP before SMTP):** Check this check box to arrange for POP authentication to be performed before sending e-mail.

**Incoming Mail Server (POP3):** Enter the address of the incoming-mail server (POP3) to be used for POP authentication.

**Account Name:** Enter the mail account.

**Password:** Enter the password.

**SMTP Authentication:** Check this check box to arrange for SMTP authentication to be performed before sending e-mail.

**Account Name:** Enter the mail account.

**Password:** Enter the password.

- 5 Confirm the contents of the e-mail report.

When you click on [View] is pressed, the contents of the e-mail report are displayed.

- 6 Send the test mail.

Check on the Send test mail check box then click on [Apply] to send your test mail to the e-mail address you set.

**Notes**

- The e-mail report function is not available because the network which Outbound Port25 Blocking is used cannot be connected to the SMTP server.
- You cannot use the following characters to enter the characters in the text box: ‘ ’, “ ”, “ \ ”, “ & ”, “ < ”, “ > ”

# Indicators

The indicators allow checking the status and notify you of abnormal operation of the projector. If the projector exhibits abnormal status, address the problem in accordance with the table below.

## ON/STANDBY indicator

Status	Meaning/Remedies
Lights in red	The projector is in Standby mode.
Flashes in green	<ul style="list-style-type: none"> <li>• The projector is ready to operate after having been turned on.</li> <li>• The lamp cools after the projector is turned off.</li> </ul>
Lights in green	The projector's power is on.
Lights in orange	The projector is in Power Saving Mode (lamp cut off).
Flashes in red	The projector is in abnormal status. Symptoms are indicated by number of flashes. Address the problem in accordance with the following. If the symptom is shown again, consult with qualified Sony personnel.
Flashes twice	<p>The internal temperature is unusually high. Check the items below.</p> <ul style="list-style-type: none"> <li>• Check to see if nothing is blocking the ventilation holes.</li> <li>• Check to see if the air filter is not clogged.</li> <li>• Check if "Installation Attitude" on the Installation menu is correctly selected.</li> </ul>
Flashes six times	Unplug the AC power cord from a wall outlet. After checking that the ON/STANDBY indicator goes out, plug the power cord to a wall outlet again then turn on the projector.
Other number of flashes	Consult with qualified Sony personnel.

## LAMP/COVER indicator

Status	Meaning/Remedies
Flashes in red	Symptoms are indicated by number of flashes. Address the problem in accordance with the following.
Flashes twice	The rear panel or air filter unit are not attached securely.
Flashes three times	The temperature of lamp is unusually high. Turn off the power and wait for lamp to cool then turn on the power again. If the symptom is shown again, the lamp may be burnt out. In such a case, replace the lamp with a new one (page 40).

# Messages List

When any of the messages listed below appears on the projected image, address the problem in accordance with the table below.

Message	Meaning/Remedy	Page
High temp.! Lamp off in 1 min.	Check the items below. <ul style="list-style-type: none"> <li>• Check to see if nothing is blocking the ventilation holes.</li> <li>• Check to see if the air filter is not clogged.</li> <li>• Check if “Installation Attitude” on the Installation menu is correctly selected.</li> </ul>	3, 29, 42
Frequency is out of range!	Change the output setting of the connected equipment to one for signals supported by the projector.	50
Please check Input-A Signal Sel.	Set “Input-A Signal Sel.” to “Auto” or select the input signal type to suit to the input signal.	28
Please replace the Lamp and clean the Filter.	Replace the lamp with a new one and clean the air filter. The message appears whenever you turn on the power until you replace the lamp and reset the lamp timer.	40, 42
Projector temperature is high. High Altitude Mode should be “On” if the projector is being used at high altitude.	At an altitude of 1,500 m or higher, if you are not using the projector, check the items below. <ul style="list-style-type: none"> <li>• Check that nothing is blocking the ventilation holes.</li> <li>• Check that the air filter is not clogged.</li> <li>• Check if “Installation Attitude” on the Installation menu is correctly selected.</li> </ul>	3, 29, 42
Not applicable!	Invalid key pressed.	5
The panel keys are locked!	“Panel Key Lock” is set to “On.”	27
Function is locked!	The function is locked by external control.	5, 14, 15, 17, 30, 30

Others

# Troubleshooting

Before asking to have the projector repaired, try to diagnose the problem, following the instructions below.

Symptom	Remedy	Page
The power is not turned on.	Check if the AC power cord is firmly connected.	–
	When the “Panel Key Lock” is set to “On,” you cannot turn on the projector using the I/⏻ key on the projector.	27
	If the lamp, rear panel, or air filter unit is not attached securely, the projector cannot be turned on.	40, 42
No image.	Check if the connecting cable is connected to external equipment properly.	8
	Check if the computer signal is set for output to an external monitor. If you set your computer, such as a notebook computer, to output the signal to both your computer’s display and an external monitor, the picture of the external monitor may not appear properly. Set your computer to output the signal to only an external monitor.	12
	Check if the input source is correctly selected.	12
	Check if the picture is muted.	6
	During “Zone Black Level Adj.” adjustment, a black image is automatically projected. (VPL-FH36/FH31 only)	17
On-screen display does not appear.	The on-screen display does not appear when “Status” in the Operation menu is set to “Off.”	27
The aspect ratio of the display is not right/the image is displayed smaller /a portion of image does not appear.	The image may not be displayed correctly with an input signal the projector cannot interpret correctly. In such a case, set “Aspect” manually.	22, 24
	Check if “Screen Aspect” is correctly selected.	29
The image is a trapezoid.	The images become trapezoidal because of the projection angle. In such a case, you can correct the trapezoidal distortion, using a Keystone feature.	5, 14, 29
The image is distorted.	Warping is set. Disable the warp correction feature. (VPL-FH36/FH31 only)	15, 30
The image is dark/too bright.	The settings for “Brightness,” “Contrast,” and “Lamp Mode” affect brightness of the image. Check if the value is appropriate.	20, 26
	The image will be dark when the lamp is burnt out. Check “Lamp Timer,” and replace the lamp with a new one if necessary.	32
The image is not clear.	Check if the projector is in focus.	13
	The picture will not be clear if condensation has accumulated on the lens. In such a case, let the projector sit for about two hours with the power on.	–

Symptom	Remedy	Page
The image is noisy.	Check if the connecting cable is connected to external equipment properly.	8
No sound.	Check that the connecting cables between the projector and external video or audio equipment are securely connected.	8
	Check if the output setting of connected external audio equipment is set for output the audio signal from the projector.	–
	Audio is not output if audio muting is activated.	6
	Check if the “Audio Output Vol.” is set to minimum.	6
The Remote Commander does not work.	Check that the batteries are installed correctly.	–
	Check that the batteries are not exhausted.	–
	Check if the “ID Mode” of the projector corresponds to that of the Remote Commander.	7, 27
	Check the setting for “IR Receiver.”	27
The fan is noisy.	The sound from the fan is often greater than normal to cool the lamp in the following cases. <ul style="list-style-type: none"> <li>• When “Lamp Mode” is set to “High.”</li> <li>• The projector is in at high altitude (“High Altitude Mode” is set to “On”)</li> <li>• Temperature is very high</li> </ul>	26, 29
	If the ventilation holes are blocked, the internal temperature of the projector rises and the fan noise becomes larger.	3
Cannot adjust the keystone setting.*	Disable the Edge Blending setting.	14, 30
	Select “HV Keystone” in “Screen Fitting.”	14, 30
Cannot adjust the Warp setting.*	Disable the Edge Blending setting.	15, 30
	Select “Warping” in “Screen Fitting.”	15, 30

**Note**

\* VPL-FH36/FH31 only

# Replacing the Lamp

Replace the lamp with a new one if a message displayed on the projected image or the LAMP/COVER indicator notifies you to replace the lamp (pages 36, 37).

Use an LMP-F230 projector lamp (for VPL-FX30)(not supplied), LMP-F272 projector lamp (for VPL-FH31/FH30)(not supplied), LMP-F331 projector lamp (for VPL-FH36/FH35/VPL-FX37)(not supplied) for replacement.

## Caution

- The lamp remains hot after the projector is turned off. **If you touch the lamp, you may burn your finger. When you replace the lamp, wait for at least an hour after turning off the projector for the lamp to cool sufficiently.**
- Do not allow any metallic or inflammable objects into the lamp replacement slot after removing the lamp, otherwise it may cause electrical shock or fire. Do not put your hands into the slot.
- **If the lamp breaks, contact qualified Sony personnel. Do not replace the lamp yourself.**
- When removing the lamp, be sure to pull it out straight, by holding it by the specified part. If you touch a part of the lamp other than the specified part, you may be burned or injured. If you pull out the lamp while the projector is tilted, the pieces may scatter if the lamp breaks any may cause injury.

- 1 Turn off the projector, and disconnect the AC power cord from a wall outlet.
- 2 When the lamp has cooled sufficiently, open the rear panel by loosening the three screws.

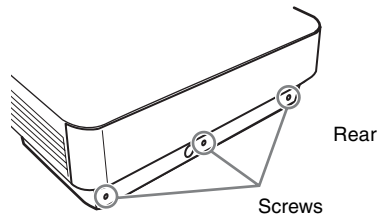

- 3 Loosen the three screws on the lamp then pull out the lamp by its grab.

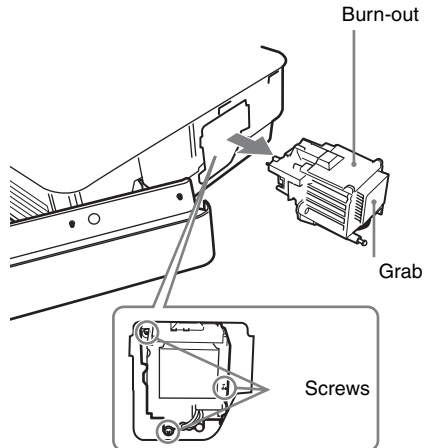



- 4 Insert the new lamp all the way in until it is securely in place. Tighten the three screws.

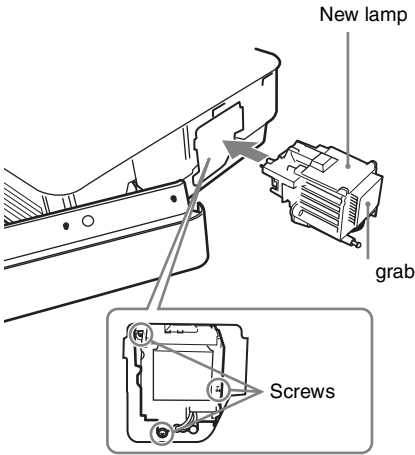

- 5 Close the rear panel and tighten the three screws.

**Note**

Be sure to install the lamp and rear panel securely as it was. If not, the projector cannot be turned on.

- 6 Connect the AC power cord to a wall outlet and turn on the projector.
- 7 Reset the lamp timer for notification of the next replacement time.  
Select “Lamp Timer Reset” on the Function menu then press the ENTER key. When a message appears, select “Yes” to reset the lamp timer.

**Disposal of the used lamp**

**For the customers in the USA**

Lamp in this product contains mercury. Disposal of these materials may be regulated due to environmental considerations. For disposal or recycling information, please contact your local authorities or the Telecommunications Industry Association ([www.eiae.org](http://www.eiae.org)).

Others

# Cleaning the Air Filter

When a message appears on the projected image indicating time for a filter cleaning, clean the air filter (pages 36, 37).

If the dust cannot be removed from the air filter even after cleaning, replace the air filter with a new one.

For details on a new air filter, consult with qualified Sony personnel.

## Caution

If you neglect to clean the air filter, dust may accumulate, clogging it. As a result, the temperature may rise inside the unit, leading to a possible malfunction or fire.

- 1 Turn off the projector, and disconnect the AC power cord from the AC outlet.
- 2 Open the rear panel by loosening the three screws on the rear panel.

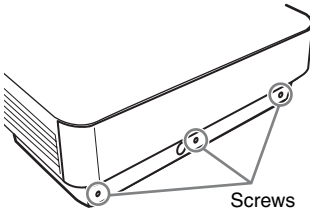

- 3 Pull out the air filter unit.

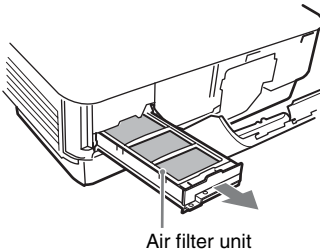

- 4 Clean the air filter with a vacuum cleaner.  
Remove the cover as illustrated below then clean the four air filters.  
The two air filters on the bottom of the air filter unit cannot be removed from the air filter unit.

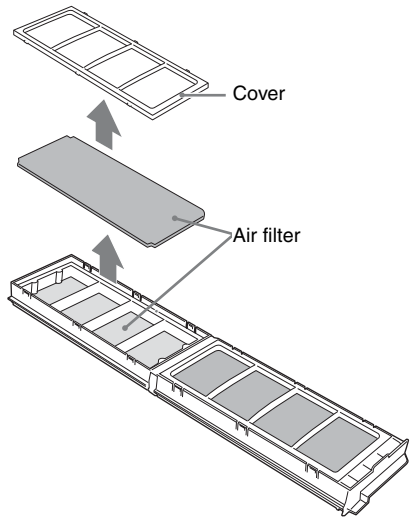

- 5 Return the air filter to the air filter unit then return it to the projector.
- 6 Close the rear panel and tighten the three screws.

## Note

Be sure to attach the air filter unit and rear panel firmly; the power cannot be turned on if it is not closed securely.

# Removing/Attaching the Projection Lens

## Notes

- Turn off the projector and disconnect the AC power cord from a wall outlet before you remove/attach the projection lens.
- Be careful not to drop the projection lens.
- Avoid removing/attaching the lens with the projector installed suspended from a ceiling.
- Avoid touching the lens surface.
- For usable projection lenses and a lens adapter, see “Optional accessories” (page 48).

## Removing

- 1 Loosen the two screws that secure the front panel to remove the front panel in the direction of the front.

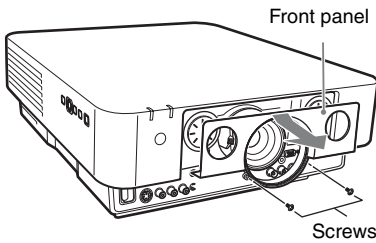

- 2 Loosen the four screws that secure the projection lens then pull it out straight.

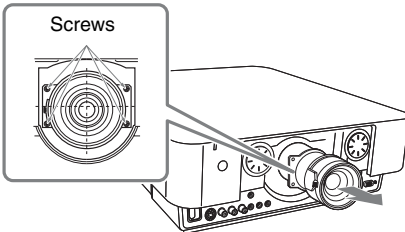

## Note

If the lens was shifted with lens shift adjustment, it may take some effort to loosen the screws. In such a case, adjust to shift the lens to the lower position and to the horizontal center position.

## Attaching

- 1 Insert the projection lens with a mark upward all the way in until it is securely in place then tighten the four screws.

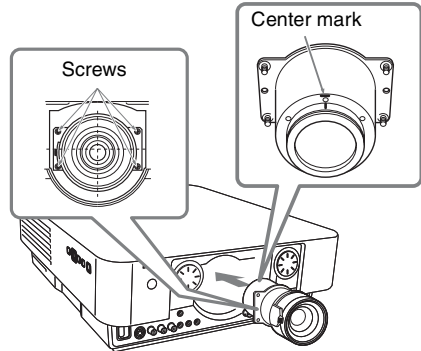

- 2 Replace the front panel and fasten it with the two screws.

## Attaching the Projection Lens Adapter to the Projection Lens

### Before starting

Since you may not recognize the center position of the projection lens after the flange section of the lens (step 1) is removed, place a mark on the projection lens with a marking pen, etc.

- 1 Place the projection lens with the motor section upward and place a mark around the top screw hole on the lens.

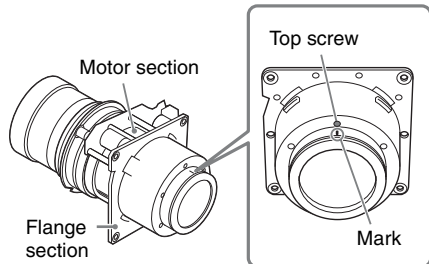

- 2** Remove the six screws that secure the flange section then slide it straight to remove.

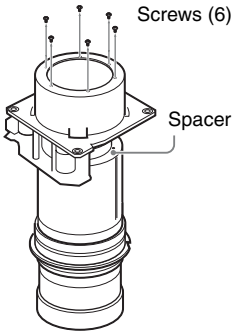

**Notes**

- The screws that secure the flange section are strongly tightened. When removing the screws, be careful not to damage the screw heads.
- When the flange section is removed, the spacer section is also loosened. Be careful that the spacer section is not removed.

- 3** Insert Part C for the lens adapter all the way until it is securely in place, align the mark with the mark placed in step 1, then tighten the six D screws supplied with the lens adapter.

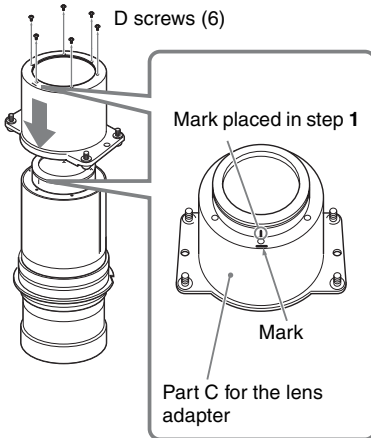

- 4** Attach Part A and Part B for the lens adapter to the projection lens.

- ① Remove the lens cap.
- ② First, fit Part A to the zoom gear section on the projection lens.
- ③ Fit the holes on Part B to the hooks on Part A then hold the projection lens between Part A and Part B for the lens adapter.

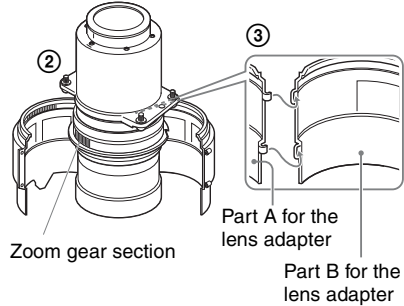

- 5** Secure Part A and Part B for the lens adapter attached to the projection lens with the two E screws supplied with the lens adapter.

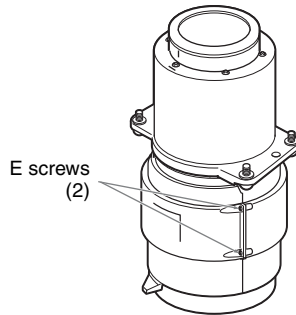

# Specifications

Item	Description	
<b>Model name</b>	<b>VPL-FH36/FH35/FH31/FH30/VPL-FX37/FX35/FX30</b>	
Display system	3 LCD system	
Display device	Size of effective display area	VPL-FH36/FH35/FH31/FH30: 0.76" (19.3 mm) × 3, Aspect ratio 16:10 VPL-FX37/FX35/FX30: 0.79" (20.1 mm) × 3, Aspect ratio 4:3
	Number of pixels	VPL-FH36/FH35/FH31/FH30: 6,912,000 (1920 × 1200 × 3) pixels VPL-FX37/FX35/FX30: 2,359,296 (1024 × 768 × 3) pixels
Projection lens	Zoom	Manual (approx. 1.6 ×)
	Focus	Manual
Light source	VPL-FH36/FH35/VPL-FX37: High-pressure mercury lamp, 330 W type VPL-FH31/FH30/VPL-FX35: High-pressure mercury lamp, 275 W type VPL-FX30: High-pressure mercury lamp, 230 W type	
Screen size	40" to 600" (1.02 m to 15.24 m)	
Light output	VPL-FH36/FH35: 5200 lm (when "Lamp Mode" is set to "High") VPL-FH31/FH30: 4300 lm (when "Lamp Mode" is set to "High") VPL-FX37: 6000 lm (when "Lamp Mode" is set to "High") VPL-FX35: 5000 lm (when "Lamp Mode" is set to "High") VPL-FX30: 4200 lm (when "Lamp Mode" is set to "High")	
Displayable scanning frequency <sup>*1</sup>	Horizontal: 14 kHz to 93 kHz, Vertical: 47 Hz to 93 Hz	
Display resolution	Computer signal input	Maximum display resolution: 1920 × 1200 dots Panel display resolution: VPL-FH36/FH35/FH31/FH30: 1920 × 1200 dots VPL-FX37/FX35/FX30: 1024 × 768 dots
	Video signal input	NTSC, PAL, SECAM, 480/60i, 576/50i, 480/60p, 576/50p, 720/60p, 720/50p, 1080/60i, 1080/50i, 1080/60p, 1080/50p, 1080/24p <sup>*2</sup>
Colour system	NTSC <sup>3.58</sup> , PAL, SECAM, NTSC <sup>4.43</sup> , PAL-M, PAL-N, PAL60	

Item	Description
<b>Model name</b>	<b>VPL-FH36/FH35/FH31/FH30/VPL-FX37/FX35/FX30</b>
Computer and video signal input/output	<p><b>INPUT A</b></p> <p><b>RGB/YPbPr input connector:</b> 5BNC female, G with sync/Y: 1 Vp-p ± 2 dB, sync negative, 75 ohms terminated, RGB/PbPr: 0.7 Vp-p ± 2 dB, 75 ohms terminated, Sync signal: TTL level high impedance, positive/negative</p> <p><b>Audio input connector:</b> Stereo mini jack, rated input 500 mVrms, input impedance more than 47 kilohms</p> <hr/> <p><b>INPUT B</b></p> <p><b>RGB input connector:</b> Mini D-sub 15-pin female, RGB: 0.7 Vp-p ± 2 dB, 75 ohms terminated, Sync signal: TTL level high impedance, positive/negative</p> <p><b>Audio input connector:</b> Stereo mini jack, rated input 500 mVrms, input impedance more than 47 kilohms</p> <hr/> <p><b>INPUT C</b></p> <p><b>DVI-D input connector:</b> DVI-D 24-pin (Single link), DVI 1.0 compliant, HDCP support</p> <p><b>Audio input connector:</b> Shared with INPUT B</p> <hr/> <p><b>INPUT D</b>*2</p> <p><b>HDMI input connector:</b> Digital RGB/YPbPr, Digital audio: PCM (32 kHz, 44.1 kHz, 48 kHz, 88.2 kHz, 96 kHz)</p> <hr/> <p><b>S VIDEO IN</b></p> <p><b>S video input connector:</b> Mini DIN 4-pin, Y: 1 Vp-p ± 2 dB, sync negative, 75 ohms terminated, C: (burst signal) 0.286 (NTSC)/0.3 (PAL/SECAM) Vp-p ± 2 dB, 75 ohms terminated</p> <p><b>Audio input connector:</b> Phono jack × 2, rated input 500 mVrms, Input impedance more than 47 kilohms</p> <hr/> <p><b>VIDEO IN</b></p> <p><b>Video input connector:</b> Phono jack, 1 Vp-p ± 2 dB, sync negative, 75 ohms terminated</p> <p><b>Audio input connector:</b> Shared with S VIDEO IN</p> <hr/> <p><b>OUTPUT</b></p> <p><b>MONITOR output connector:</b> Mini D-sub 15-pin female, G with sync/Y: 1 Vp-p ± 2 dB, sync negative, 75 ohms terminated, RGB/PbPr: 0.7 Vp-p ± 2 dB, 75 ohms terminated, Sync signal: HD, VD 4 V (open), 1 Vp-p (75 ohms), positive/negative</p> <p><b>Audio output connector:</b> Stereo mini jack, stereo, 1 Vrms (maximum volume, when inputting 500 mVrms), output impedance 5 kilohms</p> <hr/>
Control signal input/output	<p><b>RS-232C connector:</b> D-Sub 9 pin female</p> <hr/> <p><b>LAN connector:</b> RJ45, 10BASE-T/100BASE-TX</p> <hr/> <p><b>CONTROL S input connector (DC power supply):</b> Stereo mini jack, 5 Vp-p, Plug in power DC 5 V</p> <hr/>
Operating temperature/ Operating humidity	0 °C to 40 °C (32 °F to 104 °F)/35% to 85% (no condensation)
Storage temperature/ Storage humidity	-20 °C to +60 °C (-4 °F to +140 °F)/ 10% to 90%

Item	Description	
Model name	VPL-FH36/FH35/FH31/FH30/VPL-FX37/FX35/FX30	
Power requirements		VPL-FH36/FH35: 100 V to 240 V AC, 4.6 A to 1.9 A, 50/60 Hz VPL-FH31/FH30: 100 V to 240 V AC, 4 A to 1.6 A, 50/60 Hz VPL-FX37: 100 V to 240 V AC, 4.5 A to 1.8 A, 50/60 Hz VPL-FX35: 100 V to 240 V AC, 3.8 A to 1.6 A, 50/60 Hz VPL-FX30: 100 V to 240 V AC, 3.3 A to 1.3 A, 50/60 Hz
Power consumption	AC 100 V to 120 V	VPL-FH36/FH35: 460 W VPL-FH31/FH30: 400 W VPL-FX37: 450 W VPL-FX35: 380 W VPL-FX30: 330 W
	AC 220 V to 240 V	VPL-FH36/FH35: 440 W VPL-FH31/FH30: 380 W VPL-FX37: 430 W VPL-FX35: 360 W VPL-FX30: 310 W
Standby power requirements	AC 100 V to 120 V	VPL-FH36/FH31: 9.2 W (when “Standby Mode” is set to “Standard”) / 0.15 W (when “Standby Mode” is set to “Low”) VPL-FH35/FH30: 9 W (when “Standby Mode” is set to “Standard”) / 0.15 W (when “Standby Mode” is set to “Low”) VPL-FX37/FX35/FX30: 11 W (when “Standby Mode” is set to “Standard”) / 0.15 W (when “Standby Mode” is set to “Low”)
	AC 220 V to 240 V	VPL-FH36/FH31: 10.4 W (when “Standby Mode” is set to “Standard”) / 0.3 W (when “Standby Mode” is set to “Low”) VPL-FH35/FH30: 10 W (when “Standby Mode” is set to “Standard”) / 0.3 W (when “Standby Mode” is set to “Low”) VPL-FX37/FX35/FX30: 12 W (when “Standby Mode” is set to “Standard”) / 0.3 W (when “Standby Mode” is set to “Low”)
Heat dissipation	AC 100 V to 120 V	VPL-FH36/FH35: 1570 BTU VPL-FH31/FH30: 1365 BTU VPL-FX37: 1536 BTU VPL-FX35: 1297 BTU VPL-FX30: 1126 BTU
	AC 220 V to 240 V	VPL-FH36/FH35: 1501 BTU VPL-FH31/FH30: 1297 BTU VPL-FX37: 1467 BTU VPL-FX35: 1228 BTU VPL-FX30: 1058 BTU
Outside dimensions		390 × 148 × 477 mm (15 <sup>11</sup> / <sub>32</sub> " × 5 <sup>13</sup> / <sub>16</sub> " × 18 <sup>25</sup> / <sub>32</sub> ") (W/H/D) (including the lens cap for packaging) 390 × 134 × 463 mm (15 <sup>11</sup> / <sub>32</sub> " × 5 <sup>9</sup> / <sub>32</sub> " × 18 <sup>7</sup> / <sub>32</sub> ") (W/H/D) (without protrusions)

Item	Description
<b>Model name</b>	<b>VPL-FH36/FH35/FH31/FH30/VPL-FX37/FX35/FX30</b>
Mass	VPL-FH36: 8.3 kg (18 lb 5 oz) VPL-FH35/FH31: 8.2 kg (18 lb 1 oz) VPL-FH30/VPL-FX37: 8.1 kg (17 lb 14 oz) VPL-FX35: 8.0 kg (17 lb 10 oz) VPL-FX30: 7.9 kg (17 lb 7 oz)
Supplied accessories	See “Checking the Supplied Accessories” in the supplied Quick Reference Manual.
Optional accessories *3 *4	VPL-FH36/FH35/VPL-FX37: <b>Projector Lamp LMP-F331 (for replacement)</b> VPL-FH31/FH30/VPL-FX35: <b>Projection Lam LMP-F272 (for replacement)</b> VPL-FX30: <b>Projector Lamp LMP-F230 (for replacement)</b> <b>Projector Suspension Support PSS-610</b> <b>Projection Lens VPLL-Z1024*5</b> : Manual focus/zoom (when attaching to this projector), Projected image size: 40" to 600" (1.02 m to 15.24 m), Maximum external dimensions (W × H × D): 97 × 87 × 180 mm (3 <sup>13</sup> / <sub>16</sub> " × 3 <sup>7</sup> / <sub>16</sub> " × 7 <sup>3</sup> / <sub>32</sub> "), Mass: 1.1 kg (2 lb 7 oz) <b>Projection Lens VPLL-Z1032*5</b> : Manual focus/zoom (when attaching to this projector), Projected image size: 40" to 600" (1.02 m to 15.24 m), Maximum external dimensions (W × H × D): 97 × 87 × 177 mm (3 <sup>13</sup> / <sub>16</sub> " × 3 <sup>7</sup> / <sub>16</sub> " × 6 <sup>31</sup> / <sub>32</sub> "), Mass: 1.1 kg (2 lb 7 oz) <b>Projection Lens Adapter PK-F30LA1</b>

### Notes

The values for mass and dimensions are approximate.

\*1: For details, refer to “Acceptable Input Signals” on page 50.

\*2: Available for VPL-FH36/FH35/FH31/FH30 only

\*3: Not all optional accessories are available in all countries and area. Please check with your local Sony Authorized Dealer.

\*4: Information on accessories in this manual is current as of Dec. 2012.

\*5: To attach the projection lens to the projector, the PK-F30LA1 projection lens adapter is required.

Design and specifications of the unit, including the optional accessories, are subject to change without notice.

Always verify that the unit is operating properly before use. SONY WILL NOT BE LIABLE FOR DAMAGES OF ANY KIND INCLUDING, BUT NOT LIMITED TO, COMPENSATION OR REIMBURSEMENT ON ACCOUNT OF THE LOSS OF PRESENT OR PROSPECTIVE PROFITS DUE TO FAILURE OF THIS UNIT, EITHER DURING THE WARRANTY PERIOD OR AFTER EXPIRATION OF THE WARRANTY, OR FOR ANY OTHER REASON WHATSOEVER.



## Pin assignment

### DVI-D connector (DVI-D, female)

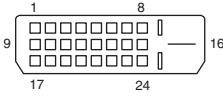

1	T.M.D.S. Data2-	14	+5 V Power
2	T.M.D.S. Data2+	15	Ground (return for +5 V)
3	T.M.D.S. Data2 Shield	16	Hot Plug Detect
4	NC	17	T.M.D.S Data0-
5	NC	18	T.M.D.S Data0+
6	DDC Clock	19	T.M.D.S Data0 Shield
7	DDC Data	20	NC
8	NC	21	NC
9	T.M.D.S. Data1-	22	T.M.D.S Clock Shield
10	T.M.D.S. Data1+	23	T.M.D.S Clock+
11	T.M.D.S. Data1 Shield	24	T.M.D.S Clock-
12	NC		
13	NC		

### RGB input connector (Mini D-sub 15-pin, female)

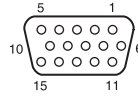

1	Video input (red) R	9	Power supply input for DDC
2	Video input (green) G	10	GND
3	Video input (blue) B	11	GND
4	GND	12	DDC/SDA
5	RESERVE	13	Horizontal sync signal
6	GND (R)	14	Vertical sync signal
7	GND (G)	15	DDC/SCL
8	GND (B)		

### RS-232C connector (D-Sub 9-pin, female)

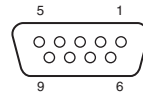

1	NC	6	NC
2	RXDA	7	RTS
3	TXDA	8	CTS
4	DTR	9	NC
5	GND		

Others

## HDMI connector (HDMI, female)

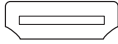

1	T.M.D.S. Data2+	11	T.M.D.S. Clock Shield
2	T.M.D.S. Data2 Shield	12	T.M.D.S. Clock-
3	T.M.D.S. Data2-	13	NC
4	T.M.D.S. Data1+	14	RECEIVED (N.C.)
5	T.M.D.S. Data1 Shield	15	SCL
6	T.M.D.S. Data1-	16	SDA
7	T.M.D.S. Data0+	17	GND
8	T.M.D.S. Data0 Shield	18	+5V Power
9	T.M.D.S. Data0-	19	Hot Plug Detect
10	T.M.D.S. Clock+		

## Acceptable Input Signals

### Computer signal

Resolution	fH [kHz]/ fV [Hz]	Input connector	
		RGB <sup>*1</sup>	DVI-D <sup>*2</sup> / HDMI <sup>*3 4 6</sup>
640 × 350	31.5/70	●	–
	37.9/85	●	–
640 × 400	31.5/70	●	–
	37.9/85	●	–
640 × 480	31.5/60	●	●
	35.0/67	●	–
	37.9/73	●	–
	37.5/75	●	–
800 × 600	43.3/85	●	–
	35.2/56	●	–
	37.9/60	●	●
	48.1/72	●	–
832 × 624	46.9/75	●	–
	53.7/85	●	–
1024 × 768	49.7/75	●	–
	48.4/60	●	●
	56.5/70	●	–
	60.0/75	●	–
1152 × 864	68.7/85	●	–
	64.0/70	●	–
	67.5/75	●	–
1152 × 900	77.5/85	●	–
	61.8/66	●	–
1280 × 960	60.0/60	●	●
	75.0/75	●	–
1280 × 1024	64.0/60	●	●
	80.0/75	●	–
	91.1/85	●	–
1400 × 1050	65.3/60	●	●
1600 × 1200	75.0/60	●	●
1280 × 768	47.8/60	●	●
1280 × 720	45.0/60	●	● <sup>*7</sup>

Resolution	fH [kHz]/ fV [Hz]	Input connector	
		RGB <sup>*1</sup>	DVI-D <sup>*2</sup> / HDMI <sup>3 4 6</sup>
1920 × 1080	67.5/60	–	● <sup>*7</sup>
1366 × 768	47.7/60	●	●
1440 × 900	55.9/60	●	●
1680 × 1050	65.3/60	●	●
1280 × 800	49.7/60	●	●
1920 × 1200	74.0/60	● <sup>*5</sup>	● <sup>*5</sup>
1600 × 900	60.0/60	● <sup>*5 *6</sup>	● <sup>*5 *6</sup>

\*6: Available for VPL-FH36/FH35/FH31/  
FH30 only

\*7: INPUT C is determined as a computer  
signal; INPUT D is determined as a digital  
TV signal.

- When a signal other than the signals listed in table is input, the picture may not be displayed properly.
- An input signal meant for screen resolution different from that of the panel will not be displayed in its original resolution. Text and lines may be uneven.
- Some actual value may differ slightly from the design values given in the table.

### Digital TV signal

Signal	fV [Hz]	Input connector	
		RGB/ YPbPr <sup>*4</sup>	DVI-D <sup>*2</sup> / HDMI <sup>3 4 6</sup>
480i	60	●	●
576i	50	●	●
480p	60	●	●
576p	50	●	●
1080i	60	●	●
1080i	50	●	●
720p	60	●	● <sup>*7</sup>
720p	50	●	●
1080p	60	–	● <sup>*7</sup>
1080p	50	–	●
1080p	24	–	● <sup>*6</sup>

### Analog TV signal

Signal	fV [Hz]	Input connector
		VIDEO/ S VIDEO
NTSC	60	●
PAL/SECAM	50	●

#### Notes

\*1: INPUT A, INPUT B

\*2: INPUT C

\*3: INPUT D

\*4: INPUT A

\*5: Available for VESA Reduced Blanking  
signals only.

**Combinations of Input Signals (VPL-FH36/FH35/FH31/FH30 only)**

Sub picture	INPUT A (RGB/YPbPr)	INPUT B (RGB)	INPUT C (DVI-D)	INPUT D (HDMI)	S VIDEO	VIDEO
<b>Main picture</b>						
<b>INPUT A (RGB/YPbPr)</b>		●	-	-	-	-
<b>INPUT B (RGB)</b>	-		-	-	-	-
<b>INPUT C (DVI-D)</b>	-	●		-	-	-
<b>INPUT D (HDMI)</b>	-	●	-		-	-
<b>S VIDEO</b>	-	●	-	-		-
<b>VIDEO</b>	-	●	-	-	-	

# Projection Distance and Lens Shift Range

The projection distance refers to the distance between the front of the lens and the projected surface.

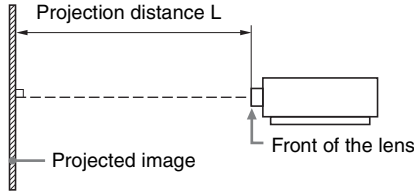

The lens shift range represents the distance in percent (%) by which the lens can be shifted from the center of the projected image. The lens shift range is regarded as 0% when the point (A) in the illustration (point where a line drawn from the center of the lens and the projected image cross at right angles) is aligned with the center of the projected image and full width or full height of the projected image is regarded as 100%.

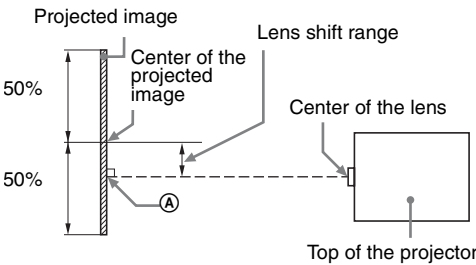
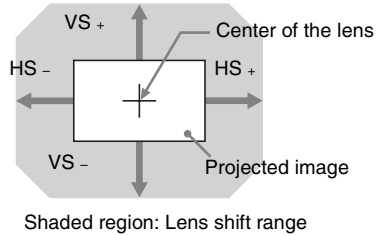
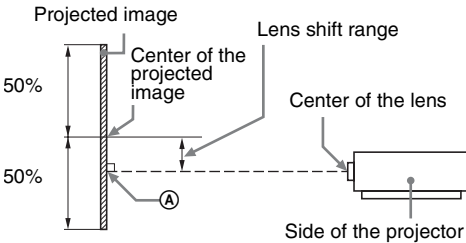

- VS +: Vertical lens shift range (up) [%]
- VS -: Vertical lens shift range (down) [%]
- HS +: Horizontal lens shift range (right) [%]
- HS -: Horizontal lens shift range (left) [%]

Others

## Projection distance (VPL-FH36/FH35/FH31/FH30)

Unit: m (inches)

Projection image size		Projection distance L		
Diagonal	Width × Height	Standard lens	VPLL-Z1024	VPLL-Z1032
80" (2.03 m)	1.72 × 1.08 (68 × 42)	2.39 – 3.83 (95 – 150)	4.00 – 5.48 (158 – 215)	5.45 – 8.32 (215 – 327)
100" (2.54 m)	2.15 × 1.35 (85 × 53)	3.00 – 4.80 (119 – 189)	5.03 – 6.87 (198 – 270)	6.84 – 10.43 (270 – 410)
120" (3.05 m)	2.58 × 1.62 (102 × 64)	3.61 – 5.77 (143 – 227)	6.05 – 8.27 (238 – 325)	8.24 – 12.55 (325 – 494)
150" (3.81 m)	3.23 × 2.02 (127 × 79)	4.53 – 7.22 (179 – 284)	7.59 – 10.36 (299 – 408)	10.33 – 15.72 (407 – 619)
200" (5.08 m)	4.31 × 2.69 (170 × 106)	6.05 – 9.64 (238 – 379)	10.15 – 13.85 (400 – 545)	13.82 – 21.00 (544 – 827)

## Projection distance formula (VPL-FH36/FH35/FH31/FH30)

D: Projected image size (Diagonal)

Unit: m (inches)

Lens	Projection distance L (minimal length)	Projection distance L (maximal length)
Standard lens	$L=0.030453 \times D - 0.0465$ ( $L=1.198941 \times D - 1.8307$ )	$L=0.048463 \times D - 0.0443$ ( $L=1.907978 \times D - 1.7435$ )
VPLL-Z1024	$L=0.051187 \times D - 0.0973$ ( $L=2.015234 \times D - 3.8296$ )	$L=0.069717 \times D - 0.0930$ ( $L=2.744761 \times D - 3.6617$ )
VPLL-Z1032	$L=0.069792 \times D - 0.1414$ ( $L=2.747720 \times D - 5.5654$ )	$L=0.105707 \times D - 0.1323$ ( $L=4.161687 \times D - 5.2083$ )

## Lens shift range (VPL-FH36/FH35/FH31/FH30)

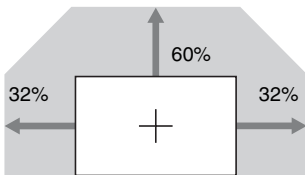

$$VS_{+} = 60 - 1.875 \times HS \text{ (HS + or HS -) } [\%]$$

$$VS_{-} = 0 [\%]$$

$$HS_{+} = HS_{-} = 32 - 0.533 \times VS_{+} [\%]$$

## Projection distance (VPL-FX37/FX35/FX30)

Unit: m (inches)

Projection image size		Projection distance L		
Diagonal	Width × Height	Standard lens	VPLL-Z1024	VPLL-Z1032
80" (2.03 m)	1.63 × 1.22 (64 × 48)	2.31 – 3.69 (91 – 145)	3.85 – 5.28 (152 – 207)	5.24 – 8.01 (207 – 315)
100" (2.54 m)	2.03 × 1.52 (80 × 60)	2.89 – 4.62 (114 – 182)	4.84 – 6.62 (191 – 260)	6.59 – 10.05 (260 – 395)
120" (3.05 m)	2.44 × 1.83 (96 × 72)	3.48 – 5.56 (137 – 218)	5.83 – 7.97 (230 – 313)	7.94 – 12.09 (313 – 476)
150" (3.81 m)	3.05 × 2.29 (120 × 90)	4.36 – 6.96 (172 – 274)	7.31 – 9.98 (288 – 393)	9.95 – 15.14 (392 – 596)
200" (5.08 m)	4.06 × 3.05 (160 × 120)	5.83 – 9.29 (230 – 366)	9.77 – 13.34 (385 – 525)	13.32 – 20.24 (525 – 797)

## Projection distance formula (VPL-FX37/FX35/FX30)

D: Projected image size (Diagonal)

Unit: m (inches)

Lens	Projection distance L (minimal length)	Projection distance L (maximal length)
Standard lens	$L=0.0294 \times D - 0.0465$ ( $L=1.1555 \times D - 1.8307$ )	$L=0.0467 \times D - 0.0443$ ( $L=1.8389 \times D - 1.7435$ )
VPLL-Z1024	$L=0.0493 \times D - 0.0973$ ( $L=1.9423 \times D - 3.8296$ )	$L=0.0672 \times D - 0.0930$ ( $L=2.6454 \times D - 3.6617$ )
VPLL-Z1032	$L=0.0673 \times D - 0.1414$ ( $L=2.6483 \times D - 5.5654$ )	$L=0.1019 \times D - 0.1323$ ( $L=4.0111 \times D - 5.2083$ )

## Lens shift range (VPL-FX37/FX35/FX30)

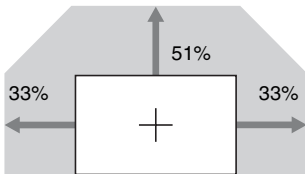

$$VS_{+} = 51 - 1.545 \times HS \text{ (HS + or HS -) } [\%]$$

$$VS_{-} = 0 [\%]$$

$$HS_{+} = HS_{-} = 33 - 0.647 \times VS_{+} [\%]$$

Others

## About lens position

The projection distance and lens shift range are measured with the lens position adjusted to the center. To adjust the lens position to the center, follow the procedures below:

- 1 Rotate the left lens shift dial left or right then align the screws with the ▲ ▼ marks in four places, as illustrated, for adjusting the lens horizontally.
- 2 Rotate the right lens shift dial clockwise until the lens is fixed, to adjust the lens vertically.

### Note

Before adjusting the lens position to the center and checking whether the lens position is centered, turn off the power to prevent projected light from entering the eyes.

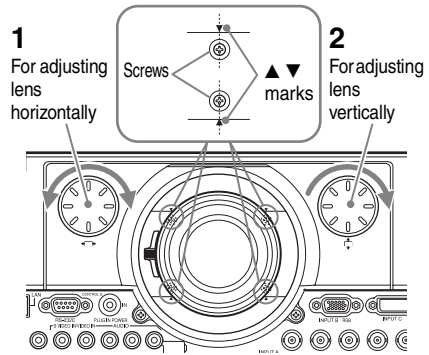





## When using the PSS-610 projector suspension support

### Caution

Never mount the projector on the ceiling or move it by yourself. Be sure to consult with qualified Sony personnel (charged).

Unit: mm (inches)

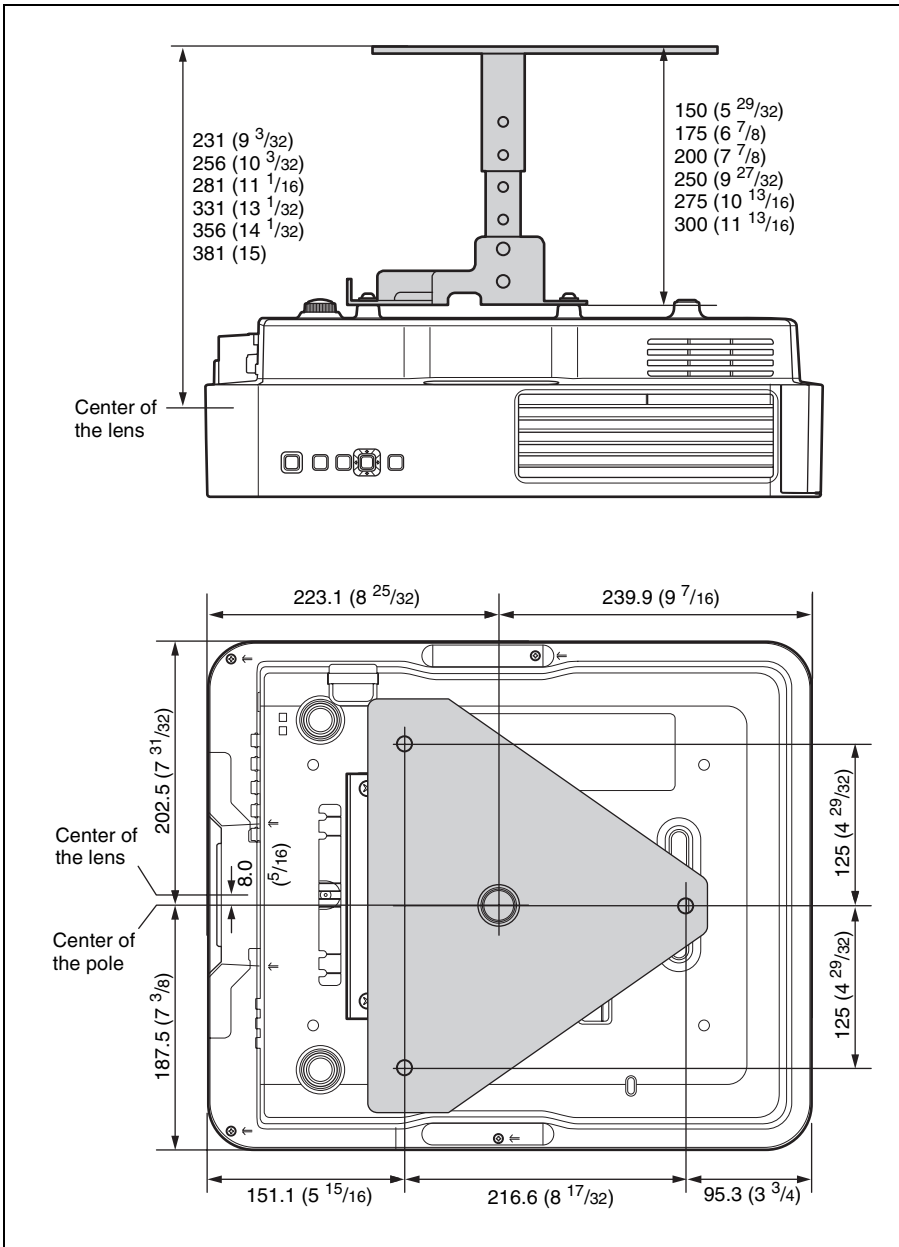

**The distance L' between the front of the lens (center) and the front of the cabinet**

Unit: mm (inches)

Lens	L'	Type
Standard lens	12.2 ( $15/32$ )	①
VPLL-Z1024	1.6 ( $1/16$ )	②
VPLL-Z1032	0.3 ( $1/32$ )	①

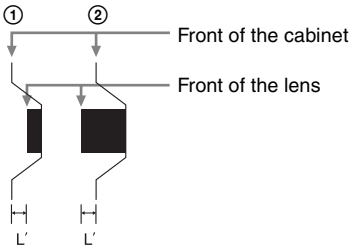

**About Trademarks**

- Adobe Acrobat is a trademark of Adobe Systems Incorporated.
- Kensington is a registered trademark of Kensington Technology Group.
- Internet Explore is registered trademarks of Microsoft Corporation in the United States and/or other countries.
- PJLink is a registered trademark of Japan Business Machine and Information System Industries Association.
- AMX is a trademark of AMX Corporation.
- The terms HDMI and HDMI High-Definition Multimedia Interface, and the HDMI Logo are trademarks or registered trademarks of HDMI Licensing LLC in the United States and other countries.
- All other trademarks and registered trademarks are trademarks or registered trademarks of their respective holders. In this manual, <sup>™</sup> and <sup>®</sup> marks are not specified.

Others

# Index

## A

AC IN socket .....	4
Acceptable input signal .....	50
Adjust Signal .....	22
Anti theft bar .....	3
Anti theft Lock .....	3
APA .....	5, 22
Aspect .....	5, 22, 24
Audio muting .....	6
Audio Output Volume .....	26

## B

Background .....	26
Black Level Adj. ....	20
Blending function .....	17
Brightness .....	20

## C

CC Display .....	26
Cleaning the air filter .....	42
Color .....	20
Color Matching .....	29, 31
Color system .....	28, 45
Color Temp. ....	20
Combinations of input signals (VPL-FH36/ FH35/FH31/FH30 only) .....	52
Connecting a computer .....	8
Connecting a video equipment .....	9
Connecting an external monitor and audio equipment .....	11
Connection/Power menu .....	28
Connector panel .....	3, 4
Contrast .....	20
Control panel .....	5
CONTROL S input connector .....	4
CONTROL S output connector .....	7

## D

Default Gateway .....	28
Digital Zoom .....	6
Dimensions .....	57
Direct Power On .....	28

## E

ECO MODE (Energy-saving mode) .....	6
Edge Blending .....	30

## F

fH .....	32
Film Mode .....	20
Focus .....	5, 13
Focus ring .....	3
Freeze .....	6
Front feet (adjustable) .....	3, 13
Front panel .....	3
Function menu .....	26
fV .....	32

## G

Gamma Mode .....	20
------------------	----

## H

H Keystone .....	30
High Altitude Mode .....	29, 30
Hue .....	20

## I

ID Mode .....	27
ID MODE 1/2/3 switch .....	7
Image Flip .....	29, 30
Information menu .....	32
Input .....	4
Input-A Signal Sel. ....	28
Installation menu .....	29
IP Address .....	28
IP Address Setup .....	28
IR Receiver .....	27

## K

Keystone adjustment .....	14
---------------------------	----

## L

Lamp Mode .....	26
Lamp Timer .....	32
Lamp Timer Reset .....	26
LAMP/COVER indicator .....	3, 36
LAN connector .....	4, 33
Language .....	27
Lens shift dial .....	3
Lens shift range .....	54, 55
Location and function of controls .....	3

## M

Main unit .....	3
Menu Position .....	27
Messages list .....	37

Model Name ..... 32

## O

ON/STANDBY indicator ..... 3, 36  
Operation menu ..... 27  
Output ..... 4  
Over Scan ..... 22

## P

Panel Alignment ..... 29, 31  
Panel Key Lock ..... 27  
Pattern ..... 5, 13  
Phase ..... 22  
Picture menu ..... 20  
Picture mode ..... 20  
Picture muting ..... 6  
Pin assignment ..... 49  
Pitch ..... 22  
Power Saving Mode ..... 28  
Primary DNS ..... 28  
Projecting an image ..... 12  
Projection distance ..... 54, 55  
Projection distance and lens shift  
    range ..... 53  
Projection distance formula ..... 54, 55

## R

Rear panel ..... 3  
Remote commander ..... 5  
Remote control detector ..... 3  
Removing/attaching the projection  
    lens ..... 43  
Replacing the lamp ..... 40  
Reset ..... 20  
RS-232C connector ..... 4

## S

Screen Aspect ..... 29, 30  
Screen menu ..... 22  
Secondary DNS ..... 28  
Security Lock ..... 27  
Selecting an input signal ..... 5  
Serial No. .... 32  
Sharpness ..... 20  
Shift ..... 5, 13, 22  
Smart APA ..... 26  
Specifications ..... 45  
Standby Mode ..... 28  
Start Up Image ..... 26  
Status ..... 27  
Subnet Mask ..... 28

## T

Troubleshooting ..... 38  
Turn off ..... 5, 18  
Turn on ..... 5, 12  
Twin picture ..... 6

## U

Using a menu ..... 19

## V

V Center ..... 22  
V Keystone ..... 29, 30  
Ventilation holes ..... 3  
Vertical Size ..... 22  
Volume ..... 6

## W

Warp correction ..... 15  
Warping ..... 30

## Z

Zoom ..... 5, 13  
Zoom lever ..... 3

