



Table of Contents

Usage Notice	2
Safety Information	2
Class B emissions limits.....	2
Important Safety Instruction.....	2
Precautions.....	4
Eye Safety Warnings.....	6
Introduction	7
Product Features	7
Package Overview	8
Product Overview.....	9
Main Unit.....	9
Control Panel.....	10
Rear View.....	11
Remote Control.....	12
Installation	13
Connecting the Projector.....	13
Connect to Computer / Notebook.....	13
Connect to Video Sources.....	14
Powering On/Off the Projector	15
Powering On the Projector	15
Powering Off the Projector.....	16
Warning Indicator.....	16
Adjusting the Projected Image.....	17
Adjusting the Projector's Height.....	17
Adjusting the Zoom / Focus.....	18
Adjusting Projection Image Size.....	19
User Controls	20
Control Panel.....	20
Remote Control	21
On-screen Display Menus.....	23
How to operate.....	23
Menu Tree	24
Image	25
Display.....	30
Setup	32
Options	43
LAN_RJ45.....	48
Appendices	51
Troubleshooting	51
Image	51
Other.....	53
Projector LED Status Indicator	54
Remote Control	55
Audio	55
Replacing the Lamp.....	56
Cleaning the Projector	58
Cleaning the Lens	58
Cleaning the Case	58
Compatibility Modes.....	59
RS232 Commands	61
RS232 Protocol Function List.....	62
Ceiling Installation.....	69
Optoma Global Offices.....	70
Regulation & Safety notices.....	72
Operation conditions.....	73

Safety Information

	The lightning flash with arrow head within an equilateral triangle is intended to alert the user to the presence of uninsulated "dangerous voltage" within the product's enclosure that may be of sufficient magnitude to constitute a risk of electric shock to persons.
	The exclamation point within an equilateral triangle is intended to alert the user to the presence of important operating and maintenance (servicing) instructions in the literature accompanying the appliance.

WARNING: TO REDUCE THE RISK OF FIRE OR ELECTRIC SHOCK, DO NOT EXPOSE THE PROJECTOR TO RAIN OR MOISTURE. DANGEROUS HIGH VOLTAGES ARE PRESENT INSIDE THE ENCLOSURE. DO NOT OPEN THE CABINET.

REFER SERVICING TO QUALIFIED PERSONNEL ONLY.

Class B emissions limits

This Class B digital apparatus meets all requirements of the Canadian Interference-Causing Equipment Regulations.

Important Safety Instruction

1. Read these instructions –before using this projector.
2. Keep these instructions –for future reference.
3. Follow all instructions.
4. Install in accordance with the manufacturer's instructions :
 - A. **Do not block any ventilation openings.** To ensure reliable operation of the projector and to protect it from overheating, put the projector in a position and location that will not interfere with its proper ventilation. For example, do not place the projector on a bed, sofa, carpet, or similar surface that may block the ventilation openings. Do not put it in an enclosure, such as a bookcase or a cabinet that may keep air from flowing through its ventilation openings.
 - B. **Do not use this projector near water or moisture.** To reduce the risk of fire or electric shock, do not expose the projector to rain or moisture.
 - C. **Do not install near any heat sources,** such as radiators, heaters, stoves or other apparatus (including amplifiers) that produce heat.
5. Clean only with a dry cloth.
6. Only use attachments/accessories specified by the manufacturer.
7. Refer all servicing to qualified service personnel. Servicing is required when the projector has been damaged in any way, such as:
 - Power supply cord or plug is damaged.
 - Liquids have spilled or objects have fallen into the apparatus.
 - The projector has been exposed to rain or moisture, does not operate normally, or has been dropped.



Usage Notice

Do not attempt to service this projector yourself. Opening or removing covers may expose you to dangerous voltages or other hazards. Please call Optoma to be referred to an authorized service center near you.

8. Do not let objects or liquids enter the projector as they may touch dangerous voltage points or short-out parts that could result in a fire or electric shock.
9. See projector enclosure for safety related markings.
10. The projector should not be adjusted or repaired by anyone except properly qualified service personnel.

Precautions



Please follow all warnings, precautions and maintenance as recommended in this user's guide.



❖ When the lamp reaches the end of its life, the projector will not turn back on until the lamp module has been replaced. To replace the lamp, follow the procedures listed under "Replacing the Lamp" section on page 56.

- Warning - Do not look into the projector's lens when the lamp is on. The bright light may damage your eyes.
- Warning - To reduce the risk of fire or electric shock, do not expose this projector to rain or moisture.
- Warning - Please do not open or disassemble the projector as this may cause electric shock.
- Warning - When replacing the lamp, please allow unit to cool down, and follow all replacement instructions. See pages 56.
- Warning - This projector will detect the life of the lamp itself. Please be sure to change the lamp when it shows warning messages.
- Warning - Use the "Lamp Reset" function from the on-screen display "Options[Lamp Setting]" menu after replacing the lamp module (see page 47).
- Warning - When switching the projector off, please ensure the cooling cycle has been completed before disconnecting the power. Allow 90 seconds for the projector to cool down.
- Warning - Do not use the lens cap when projector is in operation.
- Warning - When the lamp is approaching the end of its life, the message "Lamp is approaching the end of its useful life" displays on the screen. Please contact your local reseller or service center to change the lamp as soon as possible.
- Warning - To reduce the risk of injury to the eyes, do not look directly into the laser beam on the remote control and do not point the laser beam into anyone's eyes. This remote control is equipped with a Class II laser that emits radiation.

Do:

- ❖ Turn off the product before cleaning.
- ❖ Use a soft cloth moistened with a mild detergent to clean the display housing.
- ❖ Disconnect the power plug from the AC outlet if the product is not being used for a long period of time.

Do not:

- ❖ Block the ventilation slots and openings on the unit.
- ❖ Use abrasive cleaners, waxes or solvents to clean the unit.
- ❖ Use under the following conditions:
 - In extremely hot, cold or humid environments. Ensure that the ambient room temperature is within 5-40 °C and relative humidity is 10-85% (max.), non-condensing.
 - In areas susceptible to excessive dust and dirt.
 - Near any appliance that generates a strong magnetic field.
 - In direct sunlight.

Eye Safety Warnings



- ■ Avoid staring directly into the projector's beam of light at all times.
- ■ Minimize standing facing into the beam. Keep your back to the beam as much as possible.
- ■ Using a stick or laser pointer is recommended to avoid the need for the presenter to enter the beam.
- ■ Ensure that projectors are located out of the line of sight from the screen to the audience; this ensures that, when presenters look at the audience, they do not also have to stare at the projector lamp. The best way to achieve this is by ceiling-mounting the projector rather than placing it on floor or table top.
- ■ When projector is used in a classroom, adequately supervise students when they are asked to point out something on the screen.
- ■ In order to minimize the lamp power needed, use room blinds to reduce ambient light levels.

Product Features

This product is a single chip 0.7" XGA DLP® projector. Outstanding features include:

- ◆ Texas Instruments Single chip DLP® Technology
- ◆ Computer Compatibility:
 - Apple Macintosh, iMac, and VESA Standards:
UXGA, SXGA+, SXGA, WXGA, XGA, SVGA, VGA
- ◆ Video Compatibility:
 - NTSC, NTSC4.43
 - PAL/PAL-M/PAL-N/SECAM
 - SDTV and EDTV compatible
 - HDTV compatible (720p, 1080i, 1080p)
- ◆ Auto source detection with user definable settings
- ◆ Fully featured IR remote control with laser pointer and mouse control
- ◆ User friendly multilingual On Screen Menu
- ◆ Advanced digital keystone correction and high quality full screen image re-scaling
- ◆ User friendly control panel
- ◆ Macintosh and PC compatible
- ◆ HDMI 1.3 compatible
- ◆ Closed Captioning equipped

Package Overview

This projector comes with all the items shown below. Check to make sure your unit is complete. Contact your dealer immediately if anything is missing.

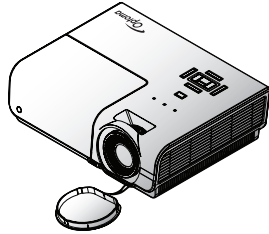

Projector with lens cap

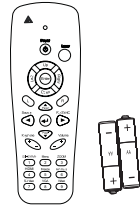

IR Remote Control
(with 2 x AAA Batteries)

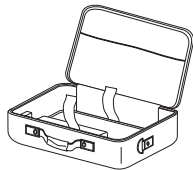

Carrying Case



Power Cord 1.8m

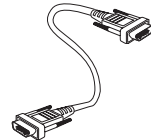

VGA Cable 1.8m



❖ Due to the difference in applications for each country, some regions may have different accessories.

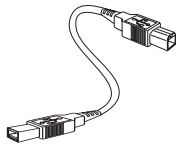

USB Cable
(A to B) 1.8m
(optional)

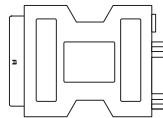

SCART to RGB &
S-Video Adapter
(optional)

Documentation:

- User's Manual
- Warranty Card
- Quick Start Card
- WEEE Card

Product Overview Main Unit

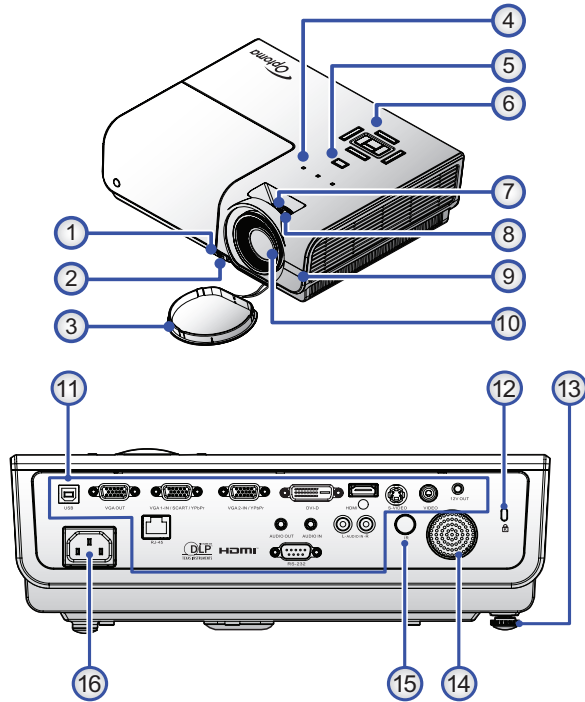

- | | |
|--------------------|------------------------------|
| 1. Elevator Button | 9. Front IR Receiver |
| 2. Elevator Foot | 10. Lens |
| 3. Lens CAP | 11. Input/Output Connections |
| 4. LED Indicators | 12. Kensington™ Lock |
| 5. Power Button | 13. Tilt-Adjustment Foot |
| 6. Control Panel | 14. Built-in Speaker |
| 7. Zoom | 15. Back IR Receiver |
| 8. Focus | 16. Power Socket |

Control Panel

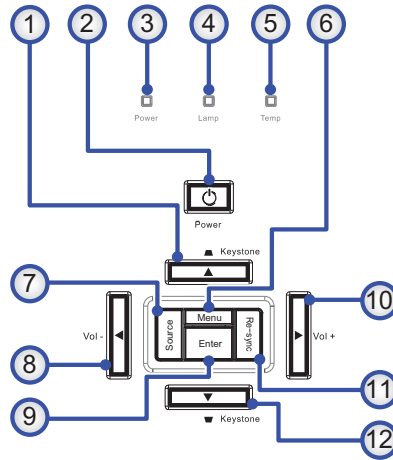

- | | |
|-------------------|--------------------|
| 1. Keystone ▲ / ▲ | 7. Source |
| 2. Power Button | 8. Vol - / ◀ |
| 3. Power LED | 9. Enter |
| 4. Lamp LED | 10. Vol + / ▶ |
| 5. Temp LED | 11. Re-Sync |
| 6. Menu | 12. Keystone ▼ / ▼ |

Rear View

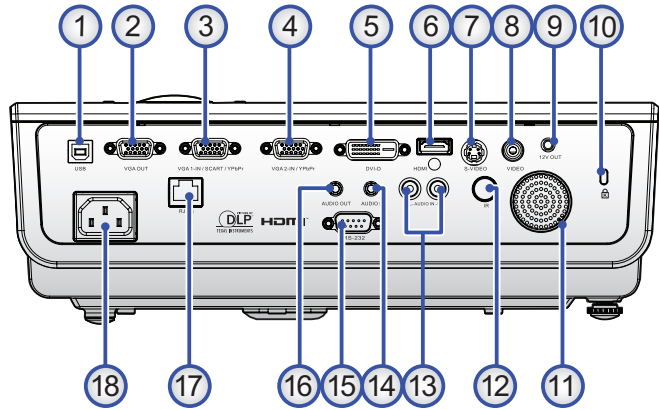

- | | |
|---|-----------------------------|
| 1. USB Connector | 9. 12V DC Connector |
| 2. VGA OUT
(External monitor connection for
VGA 1 signal) | 10. Kensington Lock |
| 3. VGA-1 IN/ SCART/ YPbPr Connector | 11. Built-in Speaker |
| 4. VGA-2 IN/ YPbPr Connector | 12. Back IR Receiver |
| 5. DVI-D Connector | 13. AUDIO IN L/R Connectors |
| 6. HDMI Connector | 14. AUDIO IN Connector |
| 7. S-VIDEO Connector | 15. RS-232 Connector |
| 8. VIDEO Connector | 16. AUDIO OUT 3.5mm Jack |
| | 17. LAN Connector |
| | 18. Power Socket |

Introduction

Remote Control

1. Laser
2. Status LED
3. Power On/Off
4. PC/Mouse Control
5. Mouse Left Click
6. Enter
7. Source / ◀
8. Keystone +/-
9. Menu/2
10. DVI-D/YPbPr/1
11. HDMI/4
12. S-Video/7
13. IR Transmitter
14. Laser
15. Mouse Right Click
16. ▲ / Page +
17. Re-Sync / ▶
18. ▼ / Page -
19. Volume +/-
20. ZOOM/3
21. AV mute/6
22. Video/9
23. Freeze/5
24. VGA/8



❖ Due to the difference in applications for each country, some regions may have different accessories.

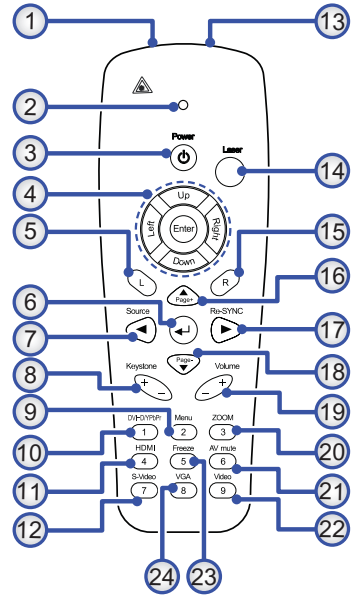

Connecting the Projector Connect to Computer / Notebook

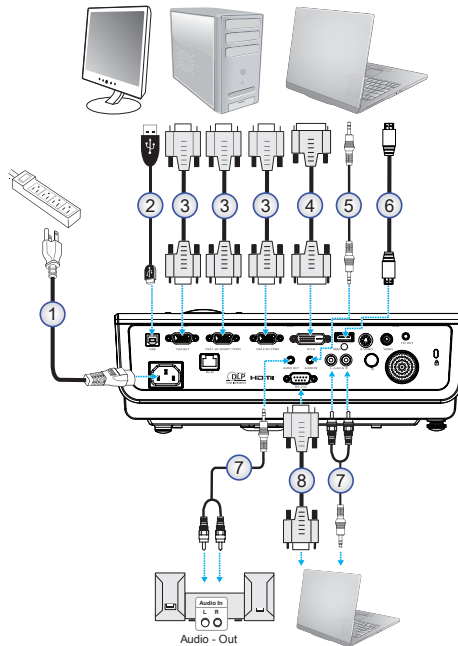

❖ Due to the difference in applications for each country, some regions may have different accessories.

1. Power Cord
2. USB Cable (Optional)
3. VGA Cable
4. DVI-D Cable (Optional)
5. Audio Cable (Optional)
6. HDMI Cable (Optional)
7. Audio Cable (Optional - RCA to mini-jack)
8. RS232 Cable (Optional)

Connect to Video Sources



❖ Due to the difference in applications for each country, some regions may have different accessories.

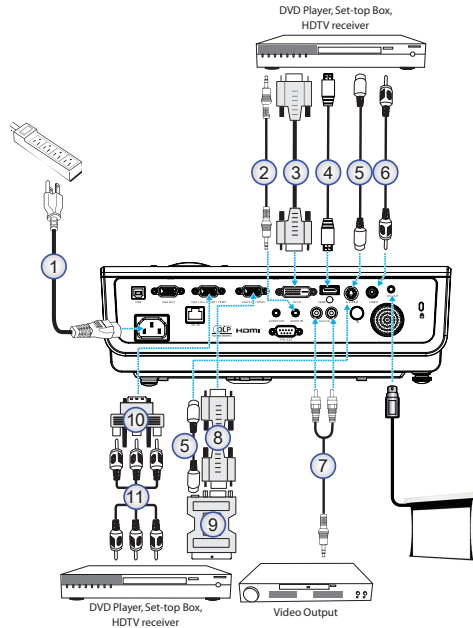

1. Power Cord
2. Audio-in Cable (Optional)
3. DVI-D Cable (Optional)
4. HDMI Cable (Optional)
5. S-Video Cable (Optional)
6. Video Cable (Optional)
7. Audio-in Cable (Optional)
8. VGA Cable
9. SCART to RGB & S-Video Adapter (Optional)
10. RGB to Component Adapter (Optional)
11. Component Cable (Optional)

Powering On/Off the Projector

Powering On the Projector

1. Remove the lens cover.
2. Connect the power cord to the projector.
3. Turn On the connected devices.
4. Ensure the Power LED is flashing and then press the **Power** button to turn On the projector.



- ❖ Turn on the projector first and then select the signal sources.

The projector's startup logo screen displays and connected devices are detected.

If the connected device is a laptop, press the appropriate keys on the computer keyboard to switch the display output to the projector. (Check the user manual of the laptop to determine the appropriate Fn key combination to change display output.)

See Security Settings on page 36 if security lock is enabled.



5. If more than one input device is connected, press the “Source” button sequentially to switch between devices. For direct source selection, see page 21.



Powering Off the Projector

1. Press **Power** to turn off the projector lamp, a message displays on the projector's screen.

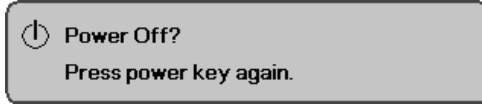

2. Press **Power** again to confirm, otherwise the message disappears after 5 seconds.
3. The cooling fans continue to operate for about 10 seconds for cooling cycle.
(If you wish to turn the projector back on, you must wait until the projector has completed the cooling cycle and has entered standby mode. Once in standby mode, simply press **Power** to restart the projector.)
4. Turn off the main power switch. Disconnect the power cord from the electrical outlet and the projector.

Warning Indicator

- ❖ When the Lamp LED indicator lights red, the projector will automatically shut itself down. Please contact your local reseller or service center. See pages 54.
- ❖ When the Temp LED is on a steady (not flashing) red, the projector will automatically shut itself down. Under normal conditions, the projector can be switched on again after it has cooled down. If the problem persists, you should contact your local dealer or our service center. See pages 54.

Adjusting the Projected Image Adjusting the Projector's Height

The projector is equipped with elevator foot for adjusting the image height.

To raise the image:

1. Lift the projector ❶.
2. Press the elevator button ❷.
3. Raise the image to the desired height angle, the elevator foot drops down ❸.
3. Fine-tune the display angle and then release the button to lock the elevator foot into position.

To lower the image:

Press the height-adjuster button and push down on the top of the projector.

To adjust the angle of the image:

Turn the tilt-adjuster ❹ right or left until the desired angle has been achieved.

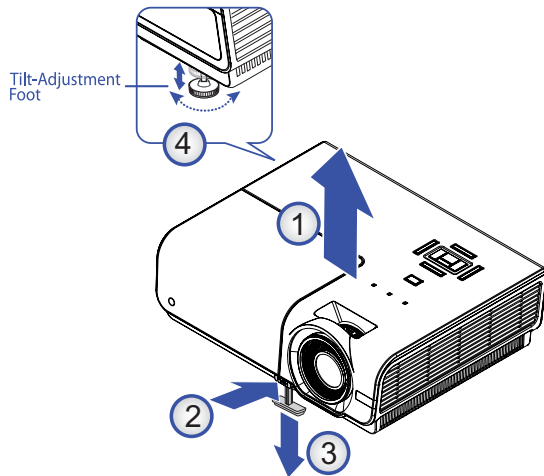

Installation

Adjusting the Zoom / Focus

You may turn the zoom ring to zoom in or out. To focus the image, rotate the focus ring until the image is clear. The projector will focus at distances. See pages 19.

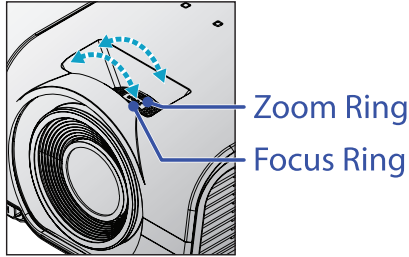

Use the keystone buttons to correct image distortion. They can be found on the remote control and on the projector's control panel.

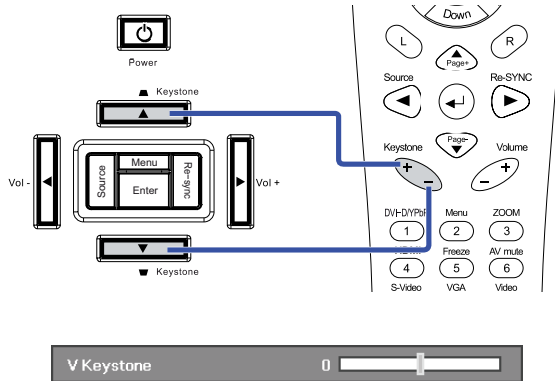

Adjusting Projection Image Size

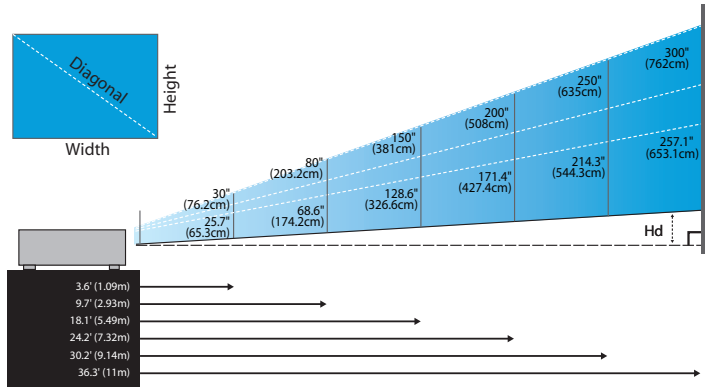

Screen (Diagonal)	Max.	30"	80"	150"	200"	250"	300"
	Min.	76.2cm	203.2cm	381cm	508cm	635cm	762cm
Screen size	Max (WxH).	25.7"	68.6"	128.6"	171.4"	214.3"	257.1"
	Min. (WxH)	65.3cm	174.2cm	326.6cm	427.4cm	544.3cm	653.1cm
Hd	Max.	24x18"	64x48"	120x90"	160x120"	200x150"	240x180"
	Min.	61x45.7cm	162.6x121.9cm	304.8x228.6cm	406.4x304.8cm	508x381cm	609x457cm
Distance	Max.	2.2"	5.8"	10.8"	14.4"	18"	21.6"
	Min.	5.5cm	14.6cm	27.4cm	36.3cm	45.7cm	54.3cm
Distance		1.9"	4.9"	9.3"	12.3"	15.4"	18.5"
Distance		4.7cm	12.5cm	23.5cm	31.4cm	39.2cm	47cm
Distance		3.6'(1.09m)	9.7'(2.93m)	18.1'(5.49m)	24.2'(7.32m)	30.2'(9.14m)	36.3'(11m)

Control Panel

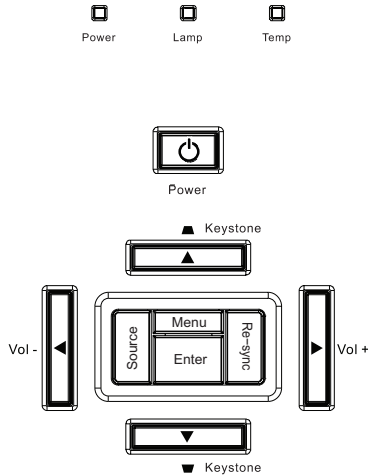







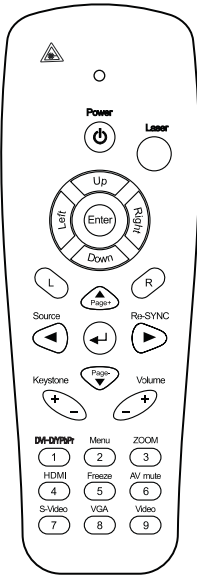







Using the Control Panel

Power LED	Green	Power On
	Off	Power Off (AC Off)
	Flashing	Standby
Lamp LED	Red	Error code
Temp LED	Red	Error code
	Flashing	Error code
Power	Turn the projector On or Off.	
▲/Keystone ▲ (Up arrow)	<ul style="list-style-type: none"> •Adjust the image Keystone positively. •Navigates and changes settings in the OSD. 	
◀/Vol - (Left arrow)	<ul style="list-style-type: none"> •Volume down •Navigates and changes settings in the OSD. 	
Source	Press Source to select an input signal.	
Menu	Press Menu to launch the on-screen display (OSD) menu. To exit OSD, Press Menu again.	
Enter	Confirm your item selection.	
Re-Sync	Automatically synchronizes the projector to the input source.	
▶/Vol + (Right arrow)	<ul style="list-style-type: none"> •Volume up •Navigates and changes settings in the OSD. 	
▼/Keystone ▼ (Down arrow)	<ul style="list-style-type: none"> •Adjust the image Keystone positively. •Navigates and changes settings in the OSD. 	

Remote Control









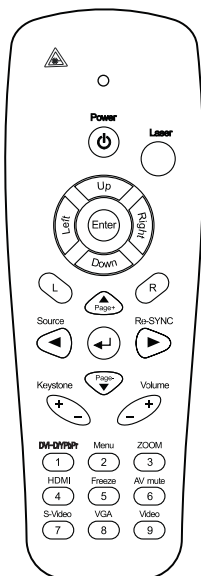





Using the Remote Control

	Power On/Off	Refer to the "Power On the Projector" section on page 15.
	Laser	Refer to the "Power Off the Projector" section on page 16.
	Laser	Press to operate the on-screen pointer.
	Up	Up arrow when connected through USB to a PC.
	Left	Left arrow when connected through USB to a PC.
	Down	Down arrow when connected through USB to a PC.
	Right	Right arrow when connected through USB to a PC.
	Enter	Enter key when connected through USB to a PC.
	L	L key for emulation of USB mouse left click via USB.
	▲	Up selection when OSD on.
	Page+	Page Up key for emulation of USB keyboard via USB when OSD off.
	R	R key for emulation of USB mouse right click via USB
	Source	Press "Source" to choose RGB, DVI-D, Component, S-Video, Composite Video, and HDMI source.
	Left Directional Select Key	Use directional select keys to select items or make adjustments to your selection.
	Enter	Confirm your item selection.

User Controls



Using the Remote Control

	Re-Sync	Automatically synchronize the projector to the input source.
	Right Directional Select Key	Use directional select keys to select items or make adjustments to your selection.
	Page-	Down selection when OSD on.
	Keystone +/-	Press Keystone +/- to correct image-trapezoid (wider top/bottom) effect.
	Volume +/-	Press Volume +/- to adjust volume.
	DVI-D/YPbPr/1	Press DVI-D/YPbPr to choose Component Video source. (DVI-D function available in this model)
	Menu/2	Display or exit the on-screen display menus for projector.
	ZOOM/3	Press ZOOM to zoom in or out images.
	HDMI/4	Press HDMI to choose source from HDMI connectors.
	Freeze/5	Press Freeze to freeze or unfreeze the on-screen picture.
	AV Mute/6	Press AV mute to mute the built-in speaker.
	S-Video/7	Press S-Video to choose S-video source.
	VGA/8	Press VGA to choose source from VGA connector.
	Video/9	Press Video to choose Composite Video source.

On-screen Display Menus

The Projector has multilingual On-screen Display menus that allow you to make image adjustments and change a variety of settings. The projector will automatically detect the source.

How to operate

1. To open the OSD menu, press **Menu** on the Remote Control or Projector Keypad.
2. When OSD is displayed, use **◀▶** keys to select any item in the main menu. While making a selection on a particular page, press **▼** or **Enter** to enter sub menu.
3. Use **▲▼** keys to select the desired item and adjust the settings by **◀▶** key.
4. Select the next item to be adjusted in the sub menu and adjust as described above.
5. Press **Enter** to confirm, and the screen will return to the main menu.
6. To exit, press **Menu** again. The OSD menu back to last level projector will automatically save the new settings.

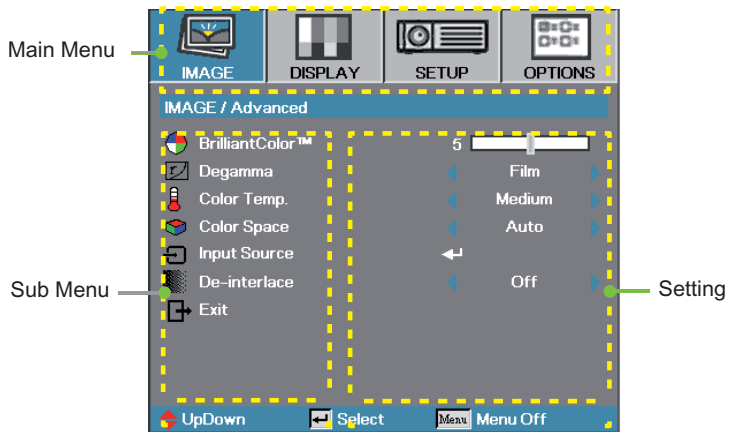

Menu Tree

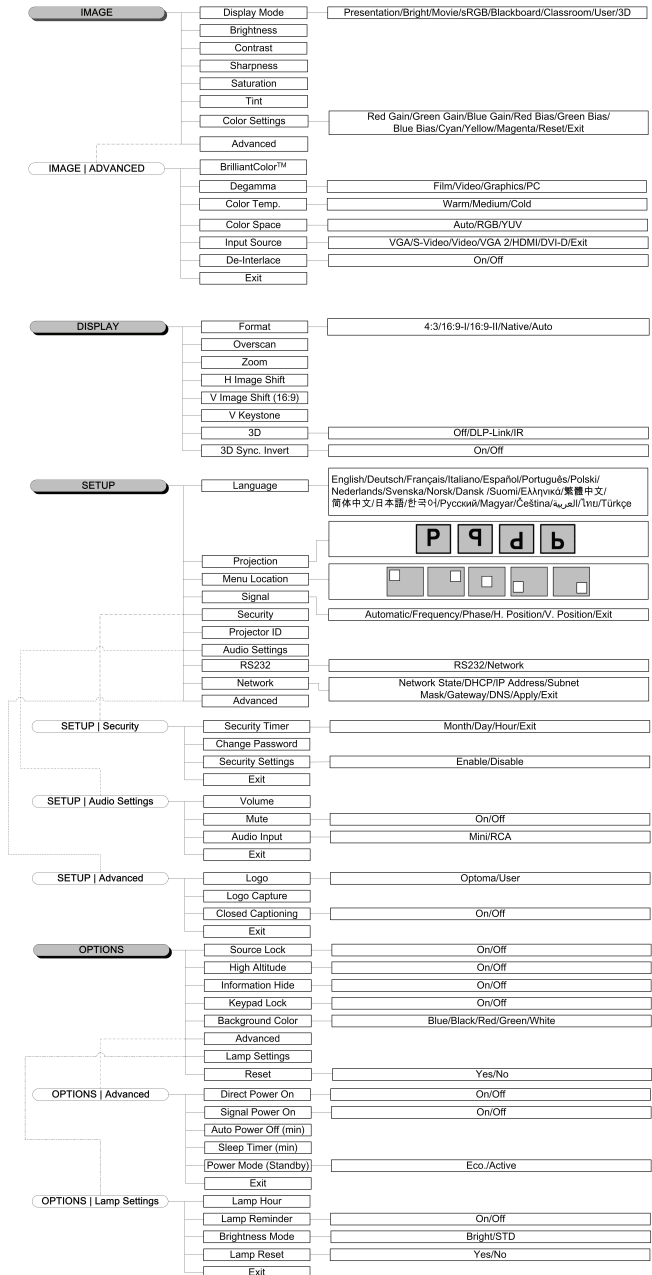

Image

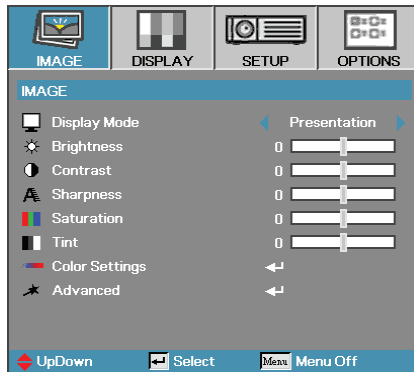

Display Mode

There are many factory presets optimized for various types of images.

- ▶ Presentation: Good color and brightness from PC input.
- ▶ Bright: Maximum brightness from PC input.
- ▶ Movie: For home theater.
- ▶ sRGB: Standardised accurate color.
- ▶ Blackboard: Tuned for blackboard usage.
- ▶ Classroom: Recommended settings for classroom.
- ▶ User: User's own settings.

The initial default settings of this mode is from Presentation / Movie mode.

Any further adjustments by the user will be saved in this mode for future use.

- ▶ 3D: Recommend setting for 3D mode enabled (DLP-Link / IR).

Brightness

Adjust the brightness of the image.

- ▶ Press ◀ to darken image.
- ▶ Press ▶ to lighten the image.

Contrast

The contrast controls the degree of difference between the lightest and darkest parts of the picture.

- ▶ Press ◀ to decrease the contrast.
- ▶ Press ▶ to increase the contrast.

Sharpness

Adjusts the sharpness of the image.

- ▶ Press ◀ to decrease the sharpness.
- ▶ Press ▶ to increase the sharpness.

Image

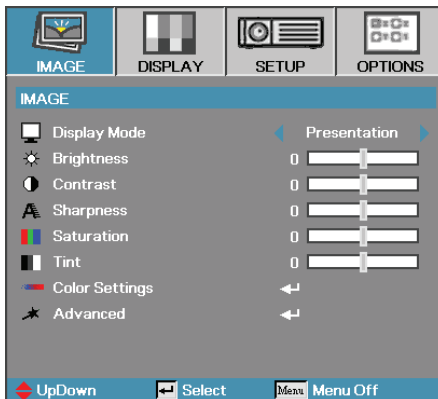

Saturation

Adjusts a video image from black and white to full color saturation.

- ▶ Press ◀ to decrease the amount of saturation in the image.
- ▶ Press ▶ to increase the amount of saturation in the image.

Tint

Adjusts the color balance of red and green.

- ▶ Press ◀ to increase the amount of green in the image.
- ▶ Press ▶ to increase the amount of red in the image.

Color Setting

Enter the Color Setting menu. Select the Red/Green/Blue Gain for brightness adjustments and Bias for contrast adjustments for the whole picture. Individual color adjustments for Cyan, Magenta, Yellow can also be adjusted. See page 27 for more details.

Advanced

Enter the Advanced menu. Select advanced display options such as BrilliantColor™, Degamma, Color Temp., Color Space, Input Source, De-Interlace, and Exit. See page 28 for more information.

Image | Color Settings

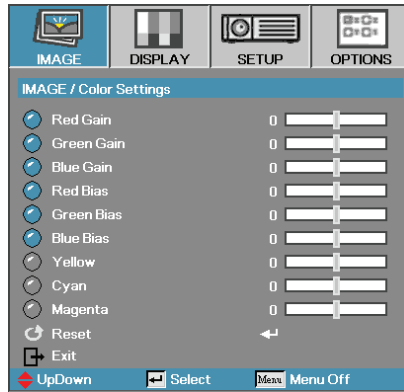

Gain

Set RGB Gain to adjust the Brightness of the follow in Colors:

- ▶ Red—increase or decrease the gain value for red.
- ▶ Green—increase or decrease the gain value for green.
- ▶ Blue—increase or decrease the gain value for blue.

Bias

Set RGB Bias to adjust the Contrast of the follow in Colors:

- ▶ Red—increase or decrease the bias value for red.
- ▶ Green—increase or decrease the bias value for green.
- ▶ Blue—increase or decrease the bias value for blue.

Color

Set values to adjust the level of the following colors:

- ▶ Yellow—increase or decrease the color value for yellow.
- ▶ Cyan—increase or decrease the color value for cyan.
- ▶ Magenta—increase or decrease the color value for magenta.

Reset

Reset all Color Setting values to the factory default.

Image / Advanced

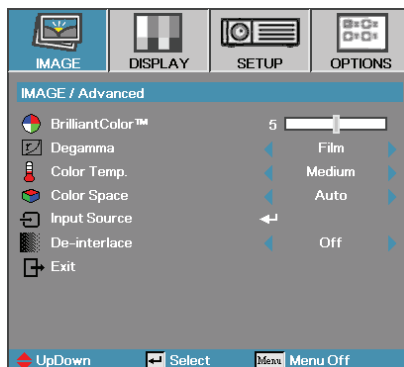

BrilliantColor™

This adjustable item utilizes a new color-processing algorithm and system level enhancements to enable higher brightness while providing true, more vibrant colors in picture. The range is from **0** to **10**. If you prefer a stronger enhanced image, adjust toward the maximum setting. For a smoother, more natural image, adjust toward the minimum setting.

Degamma

This allows you to choose a degamma table that has been fine-tuned to bring out the best image quality for the input.

- ▶ Film—for home theater.
- ▶ Video—for video or TV source.
- ▶ Graphics—for image source.
- ▶ PC—for PC or computer source.

Color Temp

Adjust the color temperature. Cold temperature, the screen looks colder; with Warm temperature, the screen looks warmer.

Color Space

Select an appropriate color matrix type from AUTO, RGB, YUV.

Input Source

Enter the Input Source submenu. Select the sources to scan for at startup. See page 29 for more information.

De-interlace

Press the cursor ◀ or ▶ button to select different De-interlace modes. This function converts an interlaced video signal into progressive signal.

- ▶ On: Use this mode for Films.
- ▶ Off: Use this mode for Video or TV sources.



- ❖ De-interlace only support 480i/576i signal via Component/S-video/Video.

Image / Advanced / Input Source



- ❖ If all sources are deselected, the projector cannot display any images. Always leave at least one source selected.

Input Source

Use this option to enable / disable input sources. Press **▲** or **▼** to select a source, then press **Enter** to enable / disable it. The projector will not search inputs that are de-selected.

Display

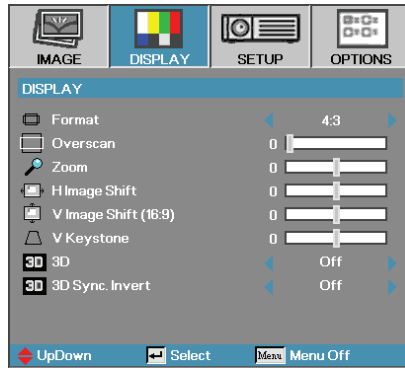

Format

Use this function to choose your desired aspect ratio.

- ▶ 4:3: This format is for 4x3 input sources not enhanced for Wide screen TV.
- ▶ 16:9 I (XGA): This format is for 16x9 input sources, like HDTV and DVD enhanced for Wide screen TV.
- ▶ 16:9 II (XGA): The non-standard wide-screen display format of the projector. Part of the original image will be cut if the image aspect ratio is less than 1.67:1.
- ▶ Native: Depends on the resolution of the input source – No scaling is performed.
- ▶ Auto: Automatically selects the appropriate format.

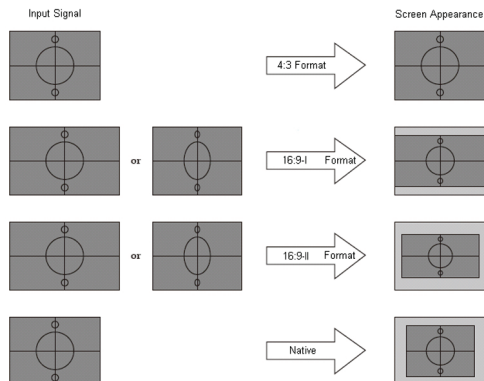

Display

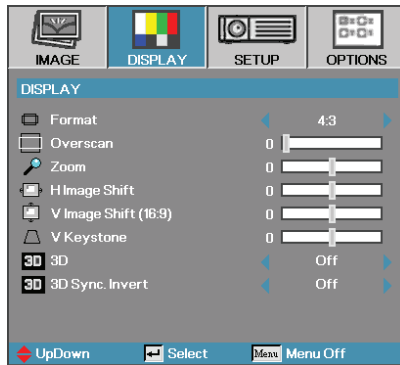

Overscan

Overscan function removes the noise in a video image. Overscan the image to remove video encoding noise on the edge of video source.

Zoom

- ▶ Press ◀ to reduce the size of the image.
- ▶ Press ▶ to magnify an image on the projected screen.

H Image Shift

Shifts the projected image position horizontally.

- ▶ Press ◀ to move the image left on the projected screen.
- ▶ Press ▶ to move the image right on the projected screen.

V Image Shift (16:9 only)

Shifts the projected image position vertically (in 16:9 format only).

- ▶ Press ▶ to move the image up on the projected screen.
- ▶ Press ◀ to move the image down on the projected screen.

V Keystone

Press ◀ or ▶ to compensate for vertical images distortion when the projector is positioned at an angle to the screen.

3D

Press ◀ or ▶ to select different 3D functions.

3D Sync invert

Press ◀ or ▶ to enable or disable the **3D Sync invert** function to invert images.

Setup

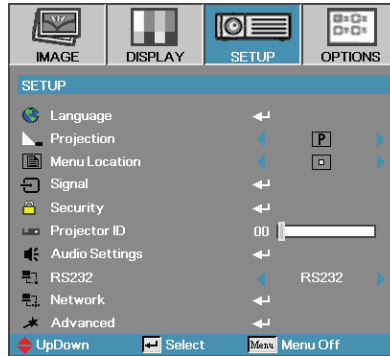

Language

Enter the Language menu. Select the multilingual OSD menu.
See page 34 for more information.

Projection

Select projection method:

- ▶ **[P]** Front Desktop
The factory default setting.
- ▶ **[R]** Rear Desktop
When you select this function, the projector reverses the image so you can project from behind a translucent screen.
- ▶ **[d]** Front Ceiling
When you select this function, the projector turns the image upside down for ceiling-mounted projection.
- ▶ **[b]** Rear Ceiling
When you select this function, the projector reverses and turns the image upside down at same time. You can project from behind a translucent screen with ceiling mounted projection.

Menu Location

Choose the menu location on the display screen.

Setup



Signal

Enter the Signal menu. Set projector signal properties. See page 35 for more information.

Security

Enter the Security menu. Access the projector's security features. See page 36 for more information.

Projector ID

Select a two digit projector ID from 0 through 99.

Audio Settings

Enter the Audio Settings menu. Set audio level properties. See page 39 for more information.

RS232

Allows RS232 control of an individual projector.

Network

Allows LAN via web browser (Internet Explore) to control of projector. See pages 40 for more information.



Advanced

Enter the Advanced menu. Select the screen display during startup. See page 42 for more information.

Setup / Language



Language

Choose the multilingual OSD menu. Press **ENTER** () into the sub menu and then use the Left () or Right () key to select your preferred language.

Setup / Signal

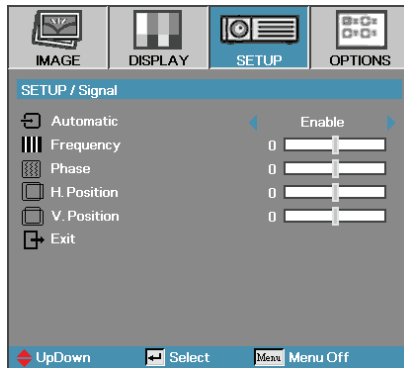

Automatic

Enable or disable Automatic to automatically select the appropriate settings.

- ▶ Enabled - the projector will automatically select the appropriate settings.
- ▶ Disabled - the projector won't automatically select the appropriate settings.

Frequency

Change the display data frequency to match the frequency of your computer's graphics card. If you experience a vertical flickering bar, use this function to make an adjustment.

Phase

Phase synchronizes the signal timing of the display with the graphics card. If you experience an unstable or flickering image, use this function to correct it.

H. Position

- ▶ Press ◀ to move the image left.
- ▶ Press ▶ to move the image right.

V. Position

- ▶ Press ▼ to move the image down.
- ▶ Press ▲ to move the image up.

Setup / Security



Security Timer

Enter the Security Timer sub menu.

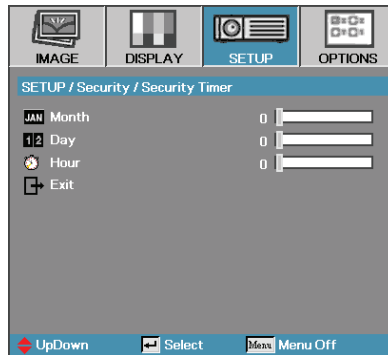

- ❖ No password is required to access Setup | Security unless the Security Timer or Security Setting are enabled.

Enter the Months, Days, and Hours that the projector can be used without entering the password. Exiting to the Setup menu activates the Security Timer.

Once activated, the projector requires a password on the specified dates and times to allow power on and access to the security menu.

If the projector is in use and the Security Timer is active, the following screen displays 60 seconds before the password is required.



Setup / Security



- ❖ If the incorrect password is entered three times, the device auto shutdowns after 10 seconds.

Change Password

Use this submenu to change the security password for the projector.

1. Select Change Password from the Security submenu. The Confirm Change Password dialog box displays.
2. Select **Yes**.

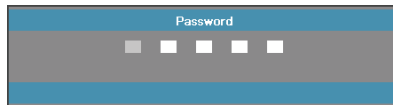

3. Enter the default password <1> <2> <3> <4> <5>. A second password screen displays.

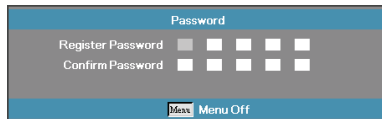

- ❖ If the new passwords do not match, the password screen redisplay.

4. Enter the new password twice for verification.

Setup / Security

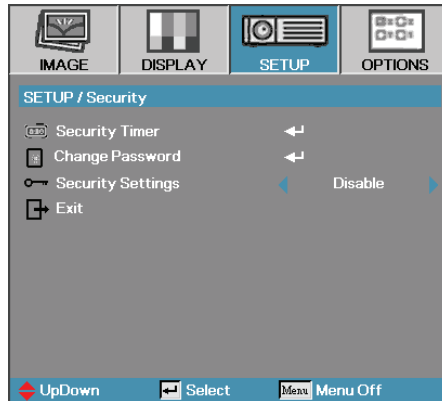

Security Settings

Enable or disable the security password.

- ▶ Enabled—the current password is required to power on the projector and access the Security menu.
- ▶ Disabled—no password is required for any function.

When security is enabled, the following screen displays at startup and before access to the Security menu is allowed:

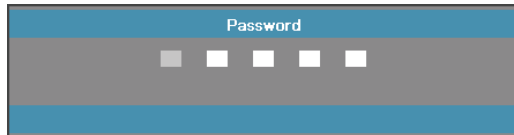

Setup / Audio Settings



Volume

Press ◀ to decrease the volume of voice.
Press ▶ to increase the volume of voice.

Mute

Toggle the audio on or off.

- ▶ Off—the speaker volume is turned on.
- ▶ On—the speaker volume is turned off.

Audio Input

Press ◀ or ▶ to select the audio input source.

Setup / Network

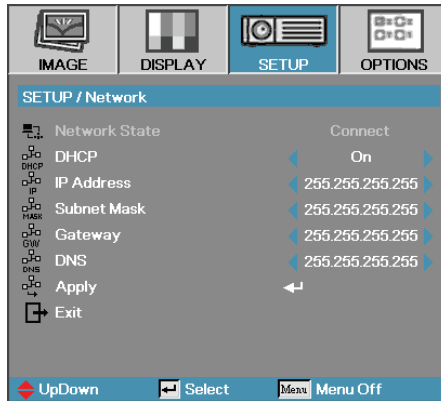

- ❖ Use straight-thru cable when connecting to a hub, switch or a router.
- ❖ Use crossover cable for direct PC to projector connection.

Network

Press **Enter** to apply Network settings. If the connection is successful, the OSD display will show the following dialogue box.

- ▶ Network State—to display network information.
- ▶ DHCP:
 - On: Assign an IP address to the projector from the DHCP server automatically.
 - Off: Assign an IP address manually.
- ▶ IP Address—Select an IP address
- ▶ Subnet Mask—Select subnet mask number.
- ▶ Gateway—Select the default gateway of the network connected to the projector.
- ▶ DNS—Select DNS number.
- ▶ Apply—Press **Enter** to apply the selection.

Setup / RS232



RS232

Press **Enter** to enter the RS232 sub menu and use the Left (◀) or Right (▶) key to select your preferred RS232 control.

When selecting **Network**, a message displays as below:

 Loading Network configuration, please wait.

Setup / Advanced

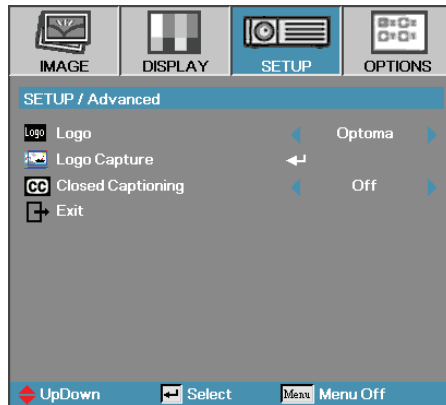

Logo

Select the screen to display during startup.

- ▶ Optoma—the supplied default startup screen.
- ▶ User—customized screen capture using the Logo Capture function.

Logo Capture

Capture a displayed screen to use as the startup screen.

1. Display the desired screen on the projector.
2. Select Logo Capture from the Advanced menu.

A confirmation screen displays.



- ❖ Only one startup screen can be saved at once.

Subsequent captures overwrite previous files.

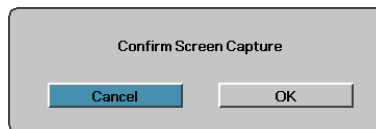

3. Select **OK**. Screen capture in progress will display. When finished, Screen capture Succeeded will display. The captured screen is saved as User in the logo menu.

Closed Captioning

Select the screen to display closed captioning

- ▶ Off—the supplied default setting.
- ▶ On-close captioning text is displayed if available.

Options

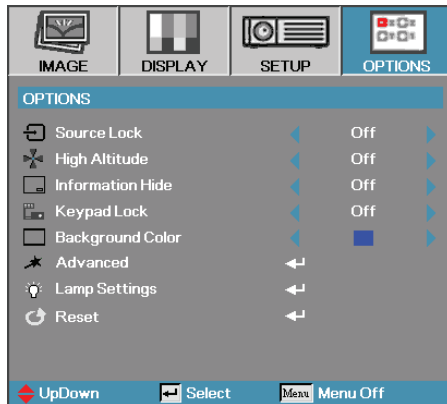

Source Lock

Lock the current source as the only available source, even if the cable is unplugged.

- ▶ On—only the current source is recognized as an input source.
- ▶ Off—all sources selected in Image | Advanced | Input Source are recognized as an input source.

High Altitude

Adjust the fan speed to reflect the environment.

- ▶ On—increases fan speed for high temperature, humidity, or altitude.
- ▶ Off—regular fan speed for normal conditions.

Information Hide

Suppress informational messages on the projected screen.

- ▶ On—no status messages appear on screen during operation.
- ▶ Off—status messages appear as normal on screen during operation.

Keypad Lock

Lock the buttons on the projector top panel.

- ▶ On—a warning message displays to confirm keypad lock.

 Hold *ENTER* key on keypad for 5 seconds to unlock keypad

- ▶ Off—projector keypad functions as normal.

Options

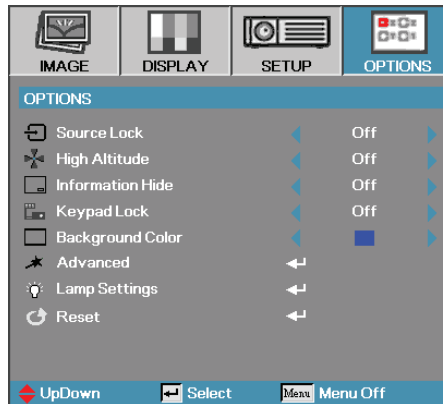

Background Color

Select the desired background color for the projected image when no source is detected.

Advanced

Enter the Advanced menu. See page 45 for more details.

Lamp Settings

Enter the Lamp Setting menu. See pages 46-47 for more details.

Reset

Reset all Options to default factory settings.

Options / Advanced

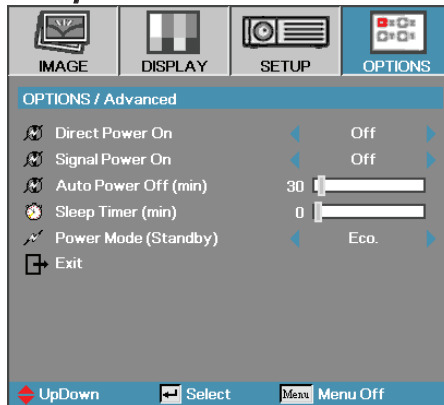

Direct Power On

Enable or disable Direct Power On.

- ▶ On— the projector powers on automatically when AC power is supplied.
- ▶ Off— the projector must be powered on as normal.

Signal Power On

Enable or disable Signal Power On.

- ▶ On— the projector turns on automatically when an active signal is detected.
- ▶ Off— the projector can be turned on by pressing the "Power" button.

Auto Power Off (min)

Set the Auto Power Off interval. The projector powers off the lamp after 30 minutes of no signal by default. The following warning is displayed 60 seconds before power off.

The projector will automatically shutdown after 60 sec

Sleep Timer (min)

Set the Sleep Timer interval. The projector powers off after the specified time period of inactivity (regardless of signal). The following warning is displayed 60 seconds before power off.

The projector will automatically shutdown after 60 sec

Power Mode (Standby)

- ▶ Eco.: Choose "Eco." to save power dissipation further < 1W.
- ▶ Active: Choose "Active" to return to normal standby and the VGA out port will be enabled.



❖ When Power mode (Standby) is set to Eco, the VGA & Audio pass-through, RS232 and RJ45 will be deactivated when the projector is in standby.

Options / Lamp Settings

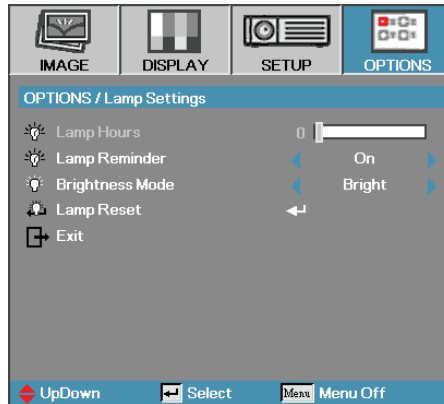

Lamp Hour

Displays the number of hours the lamp has been active. This item is for display only.

Lamp Reminder

Enable or disable the lamp life span reminder.

- ▶ On—a warning message displays when remaining lamp life is less than 30 hours.

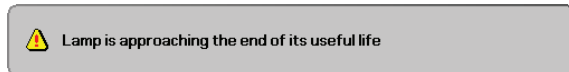

- ▶ Off—no warning message displays.

Brightness Mode

Select the lamp brightness mode.

- ▶ Bright—the default setting.
- ▶ STD—lower brightness setting to conserve lamp life.

Options / Lamp Settings

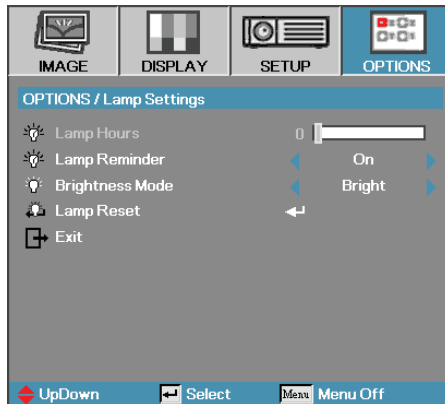

Lamp Reset

After replacing the lamp, reset the lamp counter to accurately reflect the new lamp's life span.

1. Select Lamp Reset.

A confirmation screen displays.

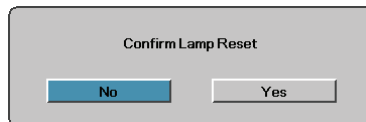

2. Select **Yes** to reset the lamp counter to zero.

User Controls



- ❖ Projector connects to LAN, please use Ethernet Normal Cable.
- ❖ Peer-to-peer (PC connects to Projector directly), please use Ethernet Crossover Cable.

LAN_RJ45

For simplicity and ease of operation, the Optoma projector provides diverse networking and remote management features.

The LAN/RJ45 function of the projector through a network, such as remotely manage: Power On/Off, Brightness and Contrast settings. Also, projector status information, such as: Video-Source, Sound-Mute, etc.

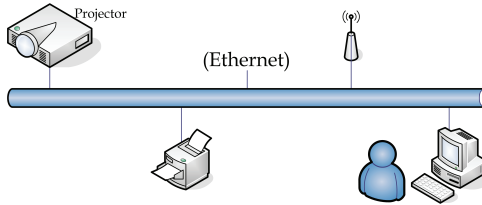

LAN RJ45

1. Connect an RJ45 cable to RJ45 ports on the projector and the PC (Laptop).

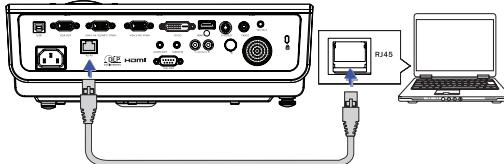

2. On the PC (Laptop), select Start -> Control Panel-> Network Connections.

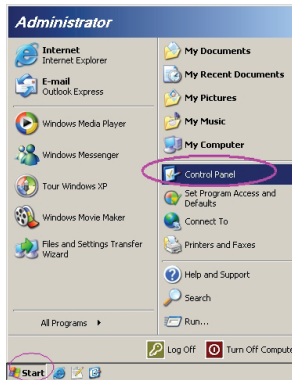

3. Right Click on your Local Area Connection, and select Property.

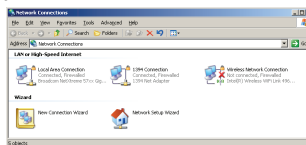

4. In the Properties window, select the **General** tab, and select **Internet Protocol (TCP/IP)**.

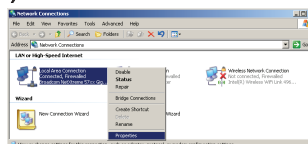

5. Click **Properties**.

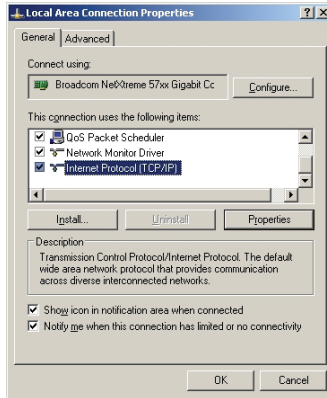

6. Fill in the IP address and Subnet mask, then press **OK**.

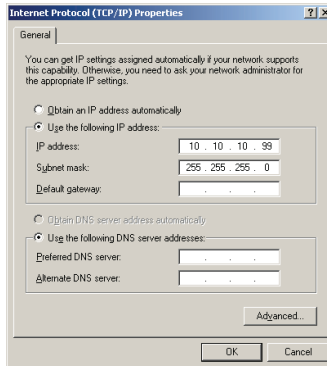

7. Press the **Menu** button on the projector.
8. Select OSD-> SETUP-> Network-> Enabled.
9. Input the following:
 - ▶ IP Address: 10.10.10.10
 - ▶ Subnet Mask: 255.255.255.0
 - ▶ Gateway: 0.0.0.0
 - ▶ DNS: 0.0.0.0
10. Press **Apply** (Enter) to confirm settings.
11. Open a web browser (ex, Microsoft Internet Explorer with Adobe Flash Player 9.0 or higher).

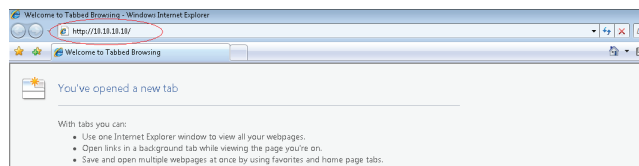

User Controls

12. In the Address bar, input the IP address: 10.10.10.10.
13. Press **Apply**.
The projector is setup for remote management. The LAN/RJ45 function displays as follows.

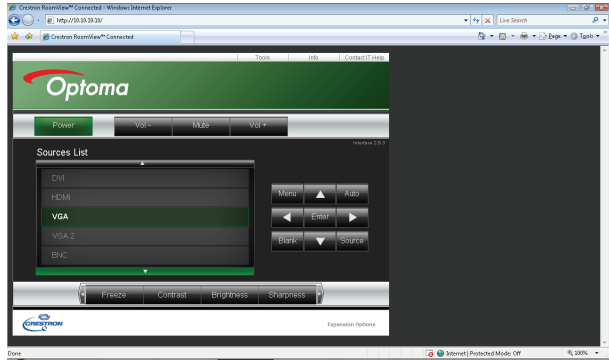

14. Based on network web-page for the input-string in [tools] tab, the limitation for Input-Length is in the below list ("space" and the other punctuation key included):



❖ For more information, please visit <http://www.crestron.com>

Category	Item	Input-Length (characters)
Crestron Control	IP Address	15
	IP ID	2
	Port	5
Projector	Projector Name	10
	Location	9
	Assigned To	9
Network Configuration	DHCP (Enabled)	(N/A)
	IP Address	15
	Subnet Mask	15
	Default Gateway	15
	DNS Server	15
User Password	Enabled	(N/A)
	New Password	15
Admin Password	Confirm	15
	Enabled	(N/A)
	New Password	15
	Confirm	15

The screenshot shows the configuration page of the Optoma web interface. It is divided into three main sections: 'Crestron Control', 'Projector', and 'User Password' / 'Admin Password'. The 'Crestron Control' section has fields for IP Address (192.168.0.20), IP ID (03), and Port (41794) with a 'Send' button. The 'Projector' section has fields for Projector Name (A01), Location (Room), and Assigned To (Sir) with a 'Send' button. The 'Network Configuration' section has a 'DHCP' checkbox (checked), IP Address (10.10.10.10), Subnet Mask (255.255.255.0), Default Gateway (0.0.0.0), and DNS Server (0.0.0.0) with a 'Send' button. The 'User Password' section has a 'New Password' field, a 'Confirm' field, and an 'Enabled' checkbox. The 'Admin Password' section has a 'New Password' field, a 'Confirm' field, and an 'Enabled' checkbox. An 'Exit' button is located at the bottom center.

Troubleshooting

If you experience a problem with your projector, please refer to the following information. If a problem persists, please contact your local reseller or service center.

Image

No image appears on-screen

- ▶ Ensure all the cables and power connections are correctly and securely connected as described in the **Installation** section.
- ▶ Ensure all the pins of connectors are not bent or broken.
- ▶ Check if the projection lamp has been securely installed. Please refer to the **Replacing the lamp** section.
- ▶ Make sure you have removed the lens cap and the projector is switched on.

Partial, scrolling or incorrectly displayed image

- ▶ Press “Re-Sync” on the remote.
- ▶ If you are using a PC:
For Windows 95, 98, 2000, XP:
 1. Open the **My Computer** icon, the **Control Panel** folder, and then double click on the **Display** icon.
 2. Select the **Settings** tab.
 3. Verify that your display resolution setting is lower than or equal to UXGA (1600 x 1200).
 4. Click on the **Advanced Properties** button.
If the projector is still not projecting the whole image, you will also need to change the monitor display you are using. Refer to the following steps.
 5. Verify the resolution setting is lower than or equal to UXGA (1600 x 1200).
 6. Select the **Change** button under the **Monitor** tab.
 7. Click on **Show all devices**. Next, select **Standard monitor types** under the SP box; choose the resolution mode you need under the “Models” box.
 8. Verify that the resolution setting of the monitor display is lower than or equal to UXGA (1600 x 1200). (*)

- ▶ If you are using a Notebook:
 1. First, follow the steps above to adjust resolution of the computer.
 2. Press the toggle output settings. Example: [Fn]+[F4]

Acer ⇒	[Fn]+[F5]	IBM/Lenovo ⇒	[Fn]+[F7]
Asus ⇒	[Fn]+[F8]	HP/Compaq ⇒	[Fn]+[F4]
Dell ⇒	[Fn]+[F8]	NEC ⇒	[Fn]+[F3]
Gateway ⇒	[Fn]+[F4]	Toshiba ⇒	[Fn]+[F5]

Mac Apple:
System Preference ⇒ Display ⇒ Arrangement ⇒ Mirror display

If you experience difficulty changing resolutions or your monitor freezes, restart all equipment including the projector.

The screen of the Notebook or PowerBook computer is not displaying your presentation

- ▶ If you are using a Notebook:

Some Notebooks may deactivate their own screens when a second display device is in use. Each has a different way to be reactivated. Refer to your computer's manual for detailed information.

Image is unstable or flickering

- ▶ Use **Phase** to correct it. See page 35 for more information.
- ▶ Change the monitor color setting on your computer.

Image has vertical flickering bar

- ▶ Use **Frequency** to make an adjustment. See page 35 for more information.
- ▶ Check and reconfigure the display mode of your graphic card to make it compatible with the projector.

Image is out of focus

- ▶ Make sure the lens cap is removed.
- ▶ Adjusts the Focus Ring on the projector lens.
- ▶ Make sure the projection screen is between the required distances from the projector. See page 19 for more information.

The image is stretched when displaying 16:9 DVD title

When you play anamorphic DVD or 16:9 DVD, the projector will show the best image in 16:9 format in OSD. If you play 4:3 format DVD title, please change the format as 4:3 in projector OSD. If the image is still stretched, you will also need to adjust the aspect ratio by referring to the following:

- ▶ Please setup the display format as 16:9 (wide) aspect ratio type on your DVD player.

Image is too small or too large

- ▶ Adjust the Zoom Ring on the top of the projector.
- ▶ Move the projector closer to or further from the screen.
- ▶ Press [Menu] button on the remote control or projector panel, go to **Display | Format** and try the different settings.

Image has slanted sides

- ▶ If possible, reposition the projector so that it is centered on the screen and below the bottom of the screen.
- ▶ Press [Keystone +/-] on the remote control until the sides are vertical.

Image is reversed

- ▶ Select **Setup | Projection** from the OSD and adjust the projection direction.

Other

















The projector stops responding to all controls

- ▶ If possible, turn off the projector, then unplug the power cord and wait at least 60 seconds before reconnecting power.

Lamp burns out or makes a popping sound

- ▶ When the lamp reaches its end of life, it will burn out and may make a loud popping sound. If this happens, the projector will not turn on until the lamp module has been replaced. To replace the lamp, follow the procedures in Replacing the Lamp on page 56.

Projector LED Status Indicator

Message	Power LED  Power (Green)	Temp LED  Temp (Red)	Lamp LED  Lamp (Red)
Standby State (Input power cord)	Slow Flashing 2 sec off 2 sec on		
Power on (Warming)	Flashing 0.5 sec off 0.5 sec on		
Power on & Lamp lighting			
Power off (Cooling)	Flashing 1 sec off 1 sec on < 10 sec to off		
Error (Lamp fail)	Flashing 0.5 sec off 0.5 sec on		
Error (Fan fail)	Flashing 0.5 sec off 0.5 sec on	Flashing 0.5 sec off 0.5 sec on	
Error (Over Temp)	Flashing 0.5 sec off 0.5 sec on		



Steady light ⇔ 

No light ⇔ 

Message Reminders

- ▶ Replacing the lamp:

 Lamp is approaching the end of its useful life

- ▶ Out of range: (see the following for more information)



Signal out of range
lower image resolution.

Remote Control

If the remote control does not work

- ▶ Check the operating angle for the remote control is approximately $\pm 15^\circ$.
- ▶ Make sure there are no obstructions between the remote control and the projector. Move to within 7m (23 ft) of the projector.
- ▶ Make sure the batteries are inserted correctly.
- ▶ Replace weak batteries in the remote control.

Audio

There is no sound

- ▶ Adjust the volume on the remote control.
- ▶ Adjust the volume of the audio source.
- ▶ Check the audio cable connection.
- ▶ Test the source audio output with other speakers.
- ▶ Have the projector serviced.

The sound is distorted

- ▶ Check the audio cable connection.
- ▶ Test the source audio output with other speakers.
- ▶ Have the projector serviced.

Replacing the Lamp

The projection lamp should be replaced when it burns out. It should only be replaced with a certified replacement part, which you can order from your local dealer.

Important:

- ▶ The lamp contains a certain amount of mercury and should be disposed of according to local ordinance regulations.
- ▶ Avoid touching the glass surface of the new lamp, doing so may shorten its operation life.



Warning:

- ▶ Be sure to turn off and unplug the projector at least an hour before replacing the lamp. Failure to do so could result in a severe burn.

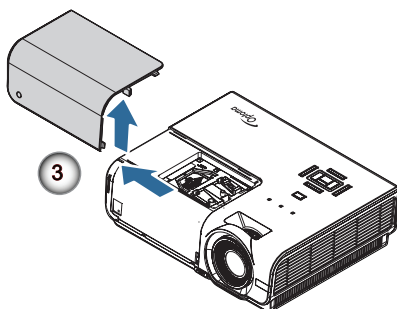
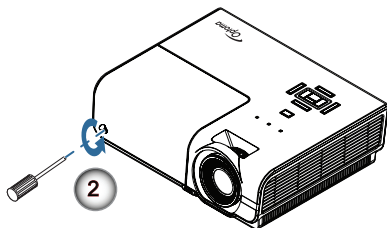
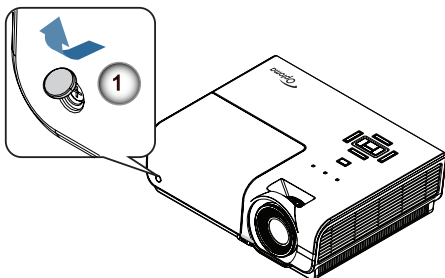

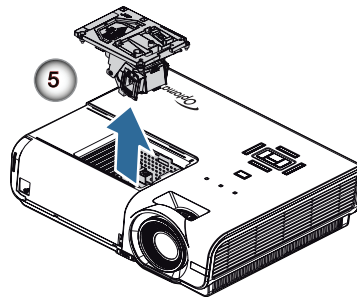
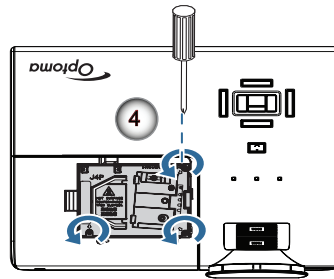

1. Switch off the power to the projector by pressing the Power button.
 2. Allow the projector to cool down at least 30 minutes.
 3. Disconnect the power cord.
 4. Open the screw cover. ❶
 5. Remove the single screw on the lamp compartment cover. ❷
 6. Remove the lamp compartment cover. ❸
 7. Remove the three screws from the lamp module.
Lift the module handle up. ❹
 8. Pull firmly on the module handle to remove the lamp module. ❺
- To replace the lamp module, reverse the previous steps. While installing, align the lamp module with the connector and ensure it is level to avoid damage.**
9. Turn on the projector and do "Lamp Reset" after the lamp module is replaced.

Lamp Reset: See page 47 for more information.

Cleaning the Projector

Cleaning the projector to remove dust and grime will help ensure trouble-free operation.

Warning:

- ▶ Be sure to turn off and unplug the projector at least an hour before cleaning. Failure to do so could result in a severe burn.
- ▶ Use only a dampened cloth when cleaning. Do not allow water to enter the ventilation openings on the projector.
- ▶ If a little water gets into the projector interior while cleaning, leave unplugged in a well-ventilated room for several hours before using.
- ▶ If a lot of water gets into the projector interior when cleaning, have the projector serviced.

Cleaning the Lens

You can purchase optic lens cleaner from most camera stores. Refer to the following to clean the projector lens.

1. Apply a little optic lens cleaner to a clean soft cloth.
(Do not apply the cleaner directly to the lens.)
2. Lightly wipe the lens in a circular motion.

Caution:

- ▶ Do not use abrasive cleaners or solvents.
- ▶ To prevent discoloration or fading, avoid getting cleaner on the projector case.

Cleaning the Case

Refer to the following to clean the projector case.

1. Wipe off dust with a clean dampened cloth.
2. Moisten the cloth with warm water and mild detergent (such as used to wash dishes), and then wipe the case.
3. Rinse all detergent from the cloth and wipe the projector again.

Caution:

To prevent discoloration or fading of the case, do not use abrasive alcohol-based cleaners.

Compatibility Modes

Computer Compatibility



- ❖ For wide screen resolution (WXGA), the compatibility support is dependent on Notebook/PC models.
- ❖ 120Hz input signals may be dependent on graphic cards support.

Signal	Resolution	Refresh Rate (Hz)
NTSC	-	60
PAL/SECAM	-	50
VESA	640 x 350	70.1/ 85.1
	640 x 400	70.1 / 85.1
	720 x 350	70
	720 x 400	70/ 85
VGA	720 x 576	50/ 60
	640 x 480	60/ 67/ 72.8/ 75/ 85
	800 x 600	56.3/ 60.3/ 75/ 72.2/ 80/ 85.1/ 120
SVGA	832 x 624	72/ 75
	1024 x 576	50/ 60
	1024 x 768	60/ 70.1/ 72/ 75/ 85/ 120
XGA	1152 x 864	60/ 70/ 75/85
	1280 x 720	50/ 60/ 75/ 85/ 120
WXGA	1280 x 768	60/ 70/ 75/ 85
WXGA-800	1280 x 800	60
SXGA	1280 x 1024	60/ 75/85
SXGA+	1400 x 1050	60
UXGA	1600 x 1200	60
	1600 x 1050	60
HDTV	1920 x 1080	25/30
	1920 x 1080i	50/ 60
	1920 x 1080p	24/25/30/50/ 60
	1280 x 720	60
SDTV	1280 x 720p	50/ 60
	720 x 576	50
	720 x 576i	50
	720 x 576p	50

Appendices

Signal	Resolution	Refresh Rate (Hz)
	720 x 480	60
	720 x 480i	60
	720 x 480p	60

Apple Mac Compatibility

Resolution	Macbook		Macbook Pro (Intel)	Power Mac G5	Power Mac G4
	Hz-	Analog	Analog	Analog	Analog
800x600	60	o	o	-	-
800x600	72	o	o	o	o
800x600	75	o	o	o	o
800x600	85	o	o	o	o
1024x768	60	o	o	o	o
1024x768	70	o	o	o	o
1024x768	75	o	o	o	o
1024x768	85	o	o	o	o
1280x720	60	o	o	o	o
1280x720	75	o	o	-	o
1280x720	85	o	o	-	o
1280x768	60	o	o	-	o
1280x768	75	o	o	o	o
1280x768	85	o	o	-	o
1280x800	60	o	o	o	o
1280x1024	60	-	o	o	o
1280x1024	75	-	o	o	-
1680x1050	60	o	o	-	-
1920x1200	60	o	o	-	-

RS232 Commands

RS232 Connector (projector side)

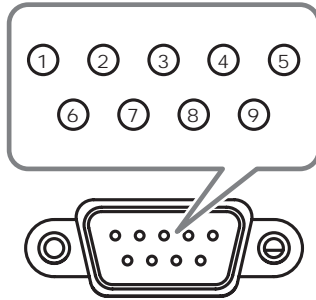

Pin No	Specification
1	N/A
2	RXD
3	TXD
4	DTR
5	GND
6	DSR
7	RTS
8	CTS
9	N/A

RS232 Protocol Function List

RS232 Commands

Baud Rate	9600
Data Bits	8
Parity Check	None
Stop Bits	1
Flow Control	None
UART16550 FIFO	Disable

Lead Code	Projector ID		Command ID			space	variable	carriage return
	X	X	X	X	X			
~	X	X	X	X	X		n	CR
Fix code One Digit	Set in OSD 00-99 Two Digit 00 is for universal use		Defined by Optoma 2 or 3 Digit See the Follow content			One Digit	Per item Definition	Fix code One Digit



❖ Due to the difference application for each model. Function is dependent on the model purchased.

Item	Key Definition	ASCII	Pass	Fail
1	Power	n=1 ~XX140 n	P	F
2	Laser	N/A		
3	Remote Mouse Up	n=3	P	F
4	Remote Mouse Left	n=4	P	F
5	Remote Mouse Enter	n=5	P	F
6	Remote Mouse Right	n=6	P	F
7	Remote Mouse Down	n=7	P	F
8	Mouse Left Click	n=8	P	F
9	Mouse Right Click	n=9	P	F
10	Up/Page +	n=10	P	F
11	Left/Source	n=11	P	F
12	Enter (for projection MENU)	n=12	P	F
13	Right/Re-SYNC	n=13	P	F
14	Down/Page -	n=14	P	F
15	Keystone +	n=15	P	F
16	Keystone -	n=16	P	F
17	Volume -	n=17	P	F
18	Volume +	n=18	P	F
19	DVI-D/YPbPr/1	n=19	P	F
20	Menu/2	n=20	P	F
21	Zoom/3	n=21	P	F
22	HDMI	n=22	P	F
23	Freeze/5	n=23	P	F
24	AV Mute/6	n=24	P	F
25	S-Video/7	n=25	P	F
26	VGA/8	n=26	P	F
27	Video/9	n=27	P	F

Keypad Command

Function			ASCII	Pass	Fail
Power	On/Off	n=1/n=2 & 0	-XX00 n	P	F
Power On with Password			-XX00 1mmmm	P	F
Re-sync		n=1	-XX01 n	P	F
AV Mute	On/Off	n=1/n=2 & 0	-XX02 n	P	F
Mute	On/Off	n=1/n=2 & 0	-XX03 n	P	F
Freeze		n=1	-XX04 n	P	F
UnFreeze		n=2 & 0	-XX04 n	P	F
HDMI		n=1	-XX12 n		
DVI-D		n=2			
VGA 1		n=5			
VGA 2		n=6			
VGA 1 SCART		n=7			
VGA 1 Component		n=8			
S-Video		n=9			
Video		n=10			
VGA 2 Component		n=13			

OSD/Image

Function			ASCII	Pass	Fail		
Display Mode	Presentation		n=1	-XX20 n	P	F	
	Bright		n=2				
	Movie		n=3				
	sRGB		n=4				
	Classroom		n=7				
	Blackboard		n=8				
	User		n=5				
	3D		n=11				
Brightness		n= -50 - +50	-XX21 n	P	F		
Contrast		n= -50 - +50	-XX22 n	P	F		
Sharpness		n= -15 - +15	-XX23 n	P	F		
Saturation		n= -50 - +50	-XX45 n	P	F		
Tint		n= -50 - +50	-XX44 n	P	F		
IMAGE Advanced	BrilliantColor™		n= 0 - 10	-XX34 n	P	F	
		Degamma	Film	n=1	-XX35 n	P	F
			Video	n=2			
			Graphics	n=3			
	Color Temp.	PC	n=4				
		Warm	n=1	-XX36 n	P	F	
		Medium	n=2				
Cold	n=3						

Appendices

Function			ASCII	Pass	Fail	
IMAGE /Advanced	Color Settings	Red Gain	n=-50 ~ 50	-XX24 n	P	F
		Green Gain	n=-50 ~ 50	-XX25 n	P	F
		Blue Gain	n=-50 ~ 50	-XX26 n	P	F
		Red Bias	n=-50 ~ 50	-XX27 n	P	F
		Green Bias	n=-50 ~ 50	-XX28 n	P	F
		Blue Bias	n=-50 ~ 50	-XX29 n	P	F
		Cyan	n=-50 ~ 50	-XX30 n	P	F
		Yellow	n=	-XX31 n	P	F
		Magenta	n=	-XX32 n	P	F
		Reset	n=1	-XX33 n	P	F
	Color Space	Auto	n=1	-XX37 n	P	F
		RGB	n=2			
		YUV	n=3			
IMAGE /Advanced	Input Source Filters	HDMI	n=1	-XX39 n	P	F
		DVI-D	n=2			
		VGA 1	n=5			
		VGA 2	n=6			
		S-Video	n=9			
		Video	n=10			
IMAGE /Advanced	De-Interlace	On	n=1	-XX40 n	P	F
		Off	n=2 & 0			

OSD/Display

Function			ASCII	Pass	Fail
Format	4:3	n=1	-XX60 n	P	F
	16:9 I	n=2			
	16:9 II	n=3			
	Native	n=6			
	Auto	n=7			
Overscan		n=0-10	-XX61 n	P	F
Zoom		n= -30 - +50	-XX62 n	P	F
H Image Shift		n= -50 - +50	-XX63 n	P	F
V Image Shift (16:9)		n= -24 - +24	-XX64 n	P	F
V Keystone		n= -30 - +30	-XX66 n	P	F
3D mode	Off	n = 1	-XX230 n		
	DLP Link	n = 2			
	IR	n =3			
3D sync invert	Off/ON	n=2 & 0	-XX231 n		

OSD/Setup

Function			ASCII	Pass	Fail	
Language	English		n=1	-XX70 n	P	F
	German		n=2			
	French		n=3			
	Italian		n=4			
	Spanish		n=5			
	Portuguese		n=6			
	Polish		n=7			
	Dutch		n=8			
	Swedish		n=9			
	Norwegian/Danish		n=10			
	Finnish		n=11			
	Greek		n=12			
	Traditional Chinese		n=13			
	Simplified Chinese		n=14			
	Japanese		n=15			
	Korean		n=16			
	Russian		n=17			
	Hungarian		n=18			
	Czechoslovak		n=19			
	Arabic		n=20			
	Thai		n=21			
	Turkish		n=22			
Projection	Front-Desktop		n=1	-XX71 n	P	F
	Rear-Desktop		n=2			
	Front-Ceiling		n=3			
	Rear-Ceiling		n=4			
Menu Location	Top Left		n=1	-XX72 n	P	F
	Top Right		n=2			
	Centre		n=3			
	Bottom Left		n=4			
	Bottom Right		n=5			
Signal	Automatic	Enable/Disable	n=1/n=0 & 2	-XX91 n	P	F
	Frequency		n= 0-31	-XX73 n	P	F
	Phase		n= -5 - +5	-XX74 n	P	F
	H. Position		n= -5 - +5	-XX75 n	P	F
	V. Position		n= -5 - +5	-XX76 n	P	F
Security	Security Timer	Hour/Day/Month	nnnnn	-XX77 n	P	F
	Change Password				send back the password to confirm	
	Security Settings	Enable/Disable	n=1/n=2 & 0	-XX78 n	P	F

Appendices

Function				ASCII	Pass	Fail
Projector ID			n=00-99	-XX79 n	P	F
Audio Settings	Mute	On/Off	n=1/n=2 &0	-XX80 n	P	F
	Volume		n=0-10	-XX81 n	P	F
	Mini-jack		n=1	-XX89 n	P	F
	RCA		n=2	-XX89 n	P	F
Advanced	Logo	Optoma/User	n=1/n=2	-XX82 n	P	F
	Logo Capture		n=1	-XX83 n	P	F
	Closed Captioning	On/Off	n=1/n=2 &0	-XX88 n	P	F
RS232		RS232	n=1	-XX86 n	P	F
		Network	n=2		P	F

OSD/Option

Function				ASCII	Pass	Fail						
Source Lock		On/Off	n=1/n=2 &0	-XX100 n	P	F						
High Altitude		On/Off	n=1/n=2 &0	-XX101 n	P	F						
Information Hide		On/Off	n=1/n=2 &0	-XX102 n	P	F						
Keypad Lock		On/Off	n=1/n=2 &0	-XX103 n	P	F						
Background Color	Blue		n=1	-XX104 n	P	F						
	Black		n=2									
	Red		n=3									
	Green		n=4									
	White		n=5									
Advanced	Direct Power On	On/Off	n=1/n=2 &0	-XX105 n	P	F						
	Signal Power On	On/Off	n=1/n=2 &0	-XX113 n	P	F						
	Auto Power Off (min)		n=0-180	-XX106 n	P	F						
	Sleep Timer (min)		n=000-995	-XX107 n	P	F						
	Power Mode(Standby)	Eco/Active	n=1/n=2 &0	-XX114 n	P	F						
Lamp Setting	Lamp Hour		n=1	-XX108 n	nmmn	F						
	Lamp Reminder	On/Off	n=1/n=2 &0	-XX109 n	P	F						
	Brightness Mode	Bright/STD	n=1/n=2	-XX110 n	P	F						
							Lamp Reset	Yes	n=1	-XX111 n	P	F
							No	n=2				
Reset		Yes	n=1	-XX112 n	P	F						
		No	n=2									
12V Trigger		Off/On	n=2 &n=1	-XX192 n	P	F						

Information Format: INFOa	Standby Mode	a=0
	Warning up	a=1
	Cooling Down	a=2
	Out of Range	a=3
	Lamp Fail	a=4
	Lamp Door Open Error / Thermal Switch Error	a=5
	Fan Lock	a=6
	Over Temperature	a=7
	Lamp Hours Running Out	a=8

Function	RS232 command	Response		
Information display	~XX150 1	Okabbbccddde		
		a = Power State	On	a=1
			Off	a=0
		b = Lamp Hour		bbbb
		c = Input Source	None	c=0
			HDMI	c=1
			DVI-D	c=2
			VGA 1	c=3
			VGA 2	c=4
			S-video	c=5
			Video	c=6
		d = Firmware Version		dddd
		e = Display mode	None	e=0
			Presentation	e=1
			Bright	e=2
			Movie	e=3
			sRGB	e=4
			Blackboard	e=5
			Classroom	e=6
User	e=7			
	3D	e=8		
Input Source	~XX121 1	Oka	None	a=0
			HDMI	a=1
			DVI-D	a=2
			VGA 1	a=3
			VGA 2	a=4
			S-video	a=5
			Video	a=6
Software Version	~XX122 1	Okdddd		
Display Mode	~XX123 1	Oka	None	a=0
			Presentation	a=1

Appendices

Function	RS232 command	Response		
			Bright	a=2
			Movie	a=3
			sRGB	a=4
			Blackboard	a=5
			Classroom	a=6
			3D	a=7
			User	a=8
Power State	~XX124 1	Oka	On	a=1
			Off	a=0
Brightness	~XX125 1	Oka		
Contrast	~XX126 1	Oka		
Aspect Ratio	~XX127 1	Oka	4:3	a=0
			16:9-I	a=1
			16:9-II	a=2
			Native	a=3
			Auto	a=4
Color Temperature	~XX128 1	Oka	Warm	a=0
			Medium	a=1
			Cold	a=2
Projection Mode	~XX129 1	Oka	Front-Desktop	a=0
			Rear-Desktop	a=1
			Front-Ceiling	a=2
			Rear-Ceiling	a=3
Model Name	~XX151 1	Oka	EX779	a=1
RS232 Version No	~XX152 1	Oka		

Ceiling Installation



- ❖ Damage to the projector as a result of incorrect installation voids the warranty.

To prevent damage to your projector please use the recommended mounting package for installation.

To ensure compliance, only use a UL Listed ceiling mount and screws that meet the following specifications:

- ▶ Screw Type: M4
- ▶ Maximum screw length: 11 mm
- ▶ Minimum screw length: 9 mm

Refer to the following diagram to ceiling mount the projector.



- ❖ Ensure at least 10cm clearance between the ceiling and the underside of the projector.
- ❖ Avoid locating the projector near heat sources such as air conditioning and heaters. Excess heat may cause the projector to power off.

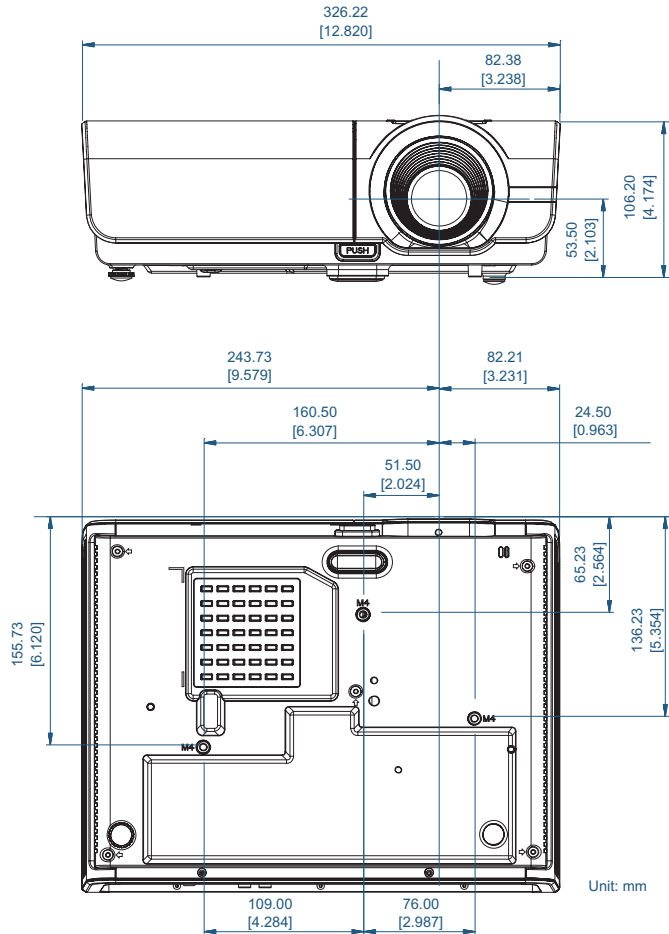

Optoma Global Offices

For service or support please contact your local office.

USA

715 Sycamore Drive
Milpitas, CA 95035, USA
www.optomausa.com

Tel : 408-383-3700
Fax : 408-383-3702
Service : services@optoma.com

Canada

5630 Kennedy Road, Mississauga,
ON, L4Z 2A9, Canada
www.optoma.ca

Tel : 905-361-2582
Fax : 905-361-2581
Service : canadacsragent@optoma.com

Europe

42 Caxton Way, The Watford Business Park
Watford, Hertfordshire,
WD18 8QZ, UK
www.optoma.eu

Tel : +44 (0) 1923 691 800
Fax : +44 (0) 1923 691 888
Service : service@tsc-europe.com

France

Bâtiment E
81-83 avenue Edouard Vaillant
92100 Boulogne Billancourt, France

Tel : +33 1 41 46 12 20
Fax : +33 1 41 46 94 35
Service : savoptoma@optoma.fr

Spain

C/ José Hierro,36 Of. 1C
28522 Rivas VaciaMadrid,
Spain

Tel : +34 91 499 06 06
Fax : +34 91 670 08 32

Deutschland

Werftstrasse 25
D40549 Düsseldorf,
Germany

Tel : +49 (0) 211 506 6670
Fax : +49 (0) 211 506 66799
Service : info@optoma.de

Optoma Scandinavia AS

Lerpeveien 25
3040 Drammen
Norway

Tel : +4732988990
FAX : +4732988999
Service : info@optoma.no

PO.BOX 9515
3038 Drammen
Norway

Latin America

715 Sycamore Drive
Milpitas, CA 95035, USA
www.optoma.com.br

Tel : 408-383-3700
Fax: 408-383-3702
www.optoma.com.mx

Taiwan

231,台北縣新店市民權路108號5樓
電話：+886-2-2218-2360
服務處：services@optoma.com.tw

傳真：+886-2-2218-2313
www.optoma.com.tw
asia.optoma.com

Hong Kong

Unit A, 27/F Dragon Centre, 79 Wing Hong Street,
Cheung Sha Wan Kowloon, Hong Kong
Tel : +852-2396-8968
www.optoma.com.hk

Fax: +852-2370-1222

China

上海市长宁区凯旋路1205号5楼
邮编: 200052
www.optoma.com.cn

电话: +86-21-62947376
传真: +86-21-62947375

Japan

東京都足立区綾瀬 3-25-18
株式会社オースエム
E-Mail: info@osscreen.com

サポートセンター: 0120-46-5040
<http://www.os-worldwide.com/>

Korea

WOOMI TECH.CO.,LTD.
4F, Minu Bldg.33-14, Nonhyun-Dong,
Kangnam-Ku, seoul, 135-815,
KOREA

Tel : +82+2+34430004
Fax: +82+2+34430005

Regulation & Safety notices

This appendix lists the general notices of your projector.

FCC notice

This device has been tested and found to comply with the limits for a Class B digital device pursuant to Part 15 of the FCC rules. These limits are designed to provide reasonable protection against harmful interference in a residential installation. This device generates, uses, and can radiate radio frequency energy and, if not installed and used in accordance with the instructions, may cause harmful interference to radio communications.

However, there is no guarantee that interference will not occur in a particular installation. If this device does cause harmful interference to radio or television reception, which can be determined by turning the device off and on, the user is encouraged to try to correct the interference by one or more of the following measures:

- ▶ Reorient or relocate the receiving antenna.
- ▶ Increase the separation between the device and receiver.
- ▶ Connect the device into an outlet on a circuit different from that to which the receiver is connected.
- ▶ Consult the dealer or an experienced radio/television technician for help.

Notice: Shielded cables

All connections to other computing devices must be made using shielded cables to maintain compliance with FCC regulations.

Caution

Changes or modifications not expressly approved by the manufacturer could void the user's authority, which is granted by the Federal Communications Commission, to operate this projector.

Operation conditions

This device complies with Part 15 of the FCC Rules. Operation is subject to the following two conditions:

1. This device may not cause harmful interference, and
2. This device must accept any interference received, including interference that may cause undesired operation.

Notice: Canadian users

This Class B digital apparatus complies with Canadian ICES-003.

Remarque à l'intention des utilisateurs canadiens

Cet appareil numérique de la classe B est conforme à la norme NMB-003 du Canada.

Declaration of Conformity for EU countries

- ▶ EMC Directive 2004/108/EC (including amendments)
- ▶ Low Voltage Directive 2006/95/EC
- ▶ R & TTE Directive 1999/5/EC (if product has RF function)

Disposal instructions



Do not throw this electronic device into the trash when discarding. To minimize pollution and ensure utmost protection of the global environment, please recycle it.