

ViewSonic®

PJD6531w DLP Projector

IMPORTANT: Please read this User Guide to obtain important information on installing and using your product in a safe manner, as well as registering your product for future service. Warranty information contained in this User Guide will describe your limited coverage from ViewSonic Corporation, which is also found on our web site at <http://www.viewsonic.com> in English, or in specific languages using the Regional selection box in the upper right corner of our website.

Antes de operar su equipo lea cuidadosamente las instrucciones en este manual



ViewSonic®

- User Guide
- Guide de l'utilisateur
- Bedienungsanleitung
- Guía del usuario
- Guida dell'utente
- Guia do usuário
- Användarhandbok
- Käyttöopas
- Руководство пользователя
- 使用手冊 (繁體)
- 使用手冊 (简体)
- 사용자 안내서
- คู่มือการใช้งาน
- Podręcznik użytkownika
- Kullanıcı kılavuzu

Model No. : VS12476

Compliance Information

FCC Statement

This device complies with part 15 of FCC Rules. Operation is subject to the following two conditions: (1) this device may not cause harmful interference, and (2) this device must accept any interference received, including interference that may cause undesired operation.

This equipment has been tested and found to comply with the limits for a Class B digital device, pursuant to part 15 of the FCC Rules. These limits are designed to provide reasonable protection against harmful interference in a residential installation. This equipment generates, uses, and can radiate radio frequency energy, and if not installed and used in accordance with the instructions, may cause harmful interference to radio communications. However, there is no guarantee that interference will not occur in a particular installation. If this equipment does cause harmful interference to radio or television reception, which can be determined by turning the equipment off and on, the user is encouraged to try to correct the interference by one or more of the following measures:

- Reorient or relocate the receiving antenna.
- Increase the separation between the equipment and receiver.
- Connect the equipment into an outlet on a circuit different from that to which the receiver is connected.
- Consult the dealer or an experienced radio/TV technician for help.

Warning: You are cautioned that changes or modifications not expressly approved by the party responsible for compliance could void your authority to operate the equipment.

For Canada

- This Class B digital apparatus complies with Canadian ICES-003.
- Cet appareil numérique de la classe B est conforme à la norme NMB-003 du Canada.

CE Conformity for European Countries

 The device complies with the EMC Directive 2004/108/EC and Low Voltage Directive 2006/95/EC.

Following information is only for EU-member states:

The mark is in compliance with the Waste Electrical and Electronic Equipment Directive 2002/96/EC (WEEE).

The mark indicates the requirement NOT to dispose the equipment including any spent or discarded batteries or accumulators as unsorted municipal waste, but use the return and collection systems available.



If the batteries, accumulators and button cells included with this equipment, display the chemical symbol Hg, Cd, or Pb, then it means that the battery has a heavy metal content of more than 0.0005% Mercury or more than, 0.002% Cadmium, or more than 0.004% Lead.



Important Safety Instructions

1. Read these instructions.
2. Keep these instructions.
3. Heed all warnings.
4. Follow all instructions.
5. Do not use this unit near water.
6. Clean with a soft, dry cloth.
7. Do not block any ventilation openings. Install the unit in accordance with the manufacturer's instructions.
8. Do not install near any heat sources such as radiators, heat registers, stoves, or other devices (including amplifiers) that produce heat.
9. Do not defeat the safety purpose of the polarized or grounding-type plug. A polarized plug has two blades with one wider than the other. A grounding type plug has two blades and a third grounding prong. The wide blade and the third prong are provided for your safety. If the provided plug does not fit into your outlet, consult an electrician for replacement of the obsolete outlet.
10. Protect the power cord from being walked on or pinched particularly at plugs. Convenience receptacles and the point where they exit from the unit. Be sure that the power outlet is located near the unit so that it is easily accessible.
11. Only use attachments/accessories specified by the manufacturer.
12.  Use only with the cart, stand, tripod, bracket, or table specified by the manufacturer, or sold with the unit. When a cart is used, use caution when moving the cart/unit combination to avoid injury from tipping over.
13. Unplug this unit when unused for long periods of time.
14. Refer all servicing to qualified service personnel. Servicing is required when the unit has been damaged in any way, such as: if the power-supply cord or plug is damaged, if liquid is spilled onto or objects fall into the unit, if the unit is exposed to rain or moisture, or if the unit does not operate normally or has been dropped.

Declaration of RoHS Compliance

This product has been designed and manufactured in compliance with Directive 2002/95/EC of the European Parliament and the Council on restriction of the use of certain hazardous substances in electrical and electronic equipment (RoHS Directive) and is deemed to comply with the maximum concentration values issued by the European Technical Adaptation Committee (TAC) as shown below:

| Substance | Proposed Maximum Concentration | Actual Concentration |
|---|---------------------------------------|-----------------------------|
| Lead (Pb) | 0.1% | < 0.1% |
| Mercury (Hg) | 0.1% | < 0.1% |
| Cadmium (Cd) | 0.01% | < 0.01% |
| Hexavalent Chromium (Cr ⁶⁺) | 0.1% | < 0.1% |
| Polybrominated biphenyls (PBB) | 0.1% | < 0.1% |
| Polybrominated diphenyl ethers (PBDE) | 0.1% | < 0.1% |

Certain components of products as stated above are exempted under the Annex of the RoHS Directives as noted below:

Examples of exempted components are:

1. Mercury in compact fluorescent lamps not exceeding 5 mg per lamp and in other lamps not specifically mentioned in the Annex of RoHS Directive.
2. Lead in glass of cathode ray tubes, electronic components, fluorescent tubes, and electronic ceramic parts (e.g. piezoelectronic devices).
3. Lead in high temperature type solders (i.e. lead-based alloys containing 85% by weight or more lead).
4. Lead as an alloying element in steel containing up to 0.35% lead by weight, aluminium containing up to 0.4% lead by weight and as a copper alloy containing up to 4% lead by weight.

Copyright Information

Copyright © ViewSonic® Corporation, 2010. All rights reserved.

Macintosh and Power Macintosh are registered trademarks of Apple Inc.

Microsoft, Windows, Windows NT, and the Windows logo are registered trademarks of Microsoft Corporation in the United States and other countries.

ViewSonic, the three birds logo, OnView, ViewMatch, and ViewMeter are registered trademarks of ViewSonic Corporation.

VESA is a registered trademark of the Video Electronics Standards Association. DPMS and DDC are trademarks of VESA.

PS/2, VGA and XGA are registered trademarks of International Business Machines Corporation.

Disclaimer: ViewSonic Corporation shall not be liable for technical or editorial errors or omissions contained herein; nor for incidental or consequential damages resulting from furnishing this material, or the performance or use of this product.

In the interest of continuing product improvement, ViewSonic Corporation reserves the right to change product specifications without notice. Information in this document may change without notice.

No part of this document may be copied, reproduced, or transmitted by any means, for any purpose without prior written permission from ViewSonic Corporation.

Product Registration

To meet your future needs, and to receive any additional product information as it becomes available, please register your product on the Internet at: www.viewsonic.com. The ViewSonic® Wizard CD-ROM also provides an opportunity for you to print the registration form, which you may mail or fax to ViewSonic.

For Your Records

| | |
|-------------------------|---|
| Product Name: | PJD6531w ViewSonic DLP Projector |
| Model Number: | VS12476 |
| Document Number: | PJD6531w_UG_ENG Rev. 1A 01-01-10 |
| Serial Number: | _____ |
| Purchase Date: | _____ |



The lamp in this product contains mercury.

Please dispose of in accordance with local, state or federal laws.

Notes on the AC Power Cord

AC Power Cord must meet the requirement of countries where you use this projector. Please confirm your AC plug type with the graphics below and ensure that the proper AC Power Cord is used. If the supplied AC Power Cord does not match your AC outlet, please contact your sales dealer. This projector is equipped with a grounding type AC line plug. Please ensure that your outlet fits the plug. Do not defeat the safety purpose of this grounding type plug. We highly recommend using a video source device also equipped with a grounding type AC line plug to prevent signal interference due to voltage fluctuations.

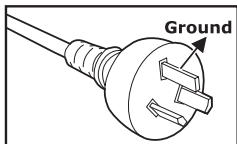

For Australia and
Mainland China

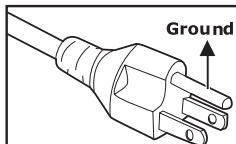

For the U.S.A. and Canada

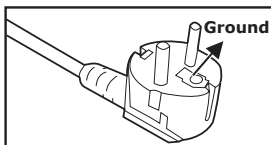

For Continental Europe

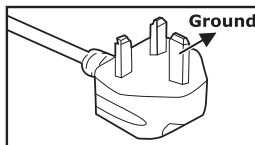

For the U.K.

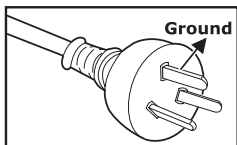

For Argentina

CONTENTS

| | |
|--|-----------|
| Introduction | 5 |
| Projector Features | 5 |
| Package Contents | 6 |
| Projector Overview | 7 |
| Using the Product | 9 |
| Control Panel | 9 |
| Connection Ports | 10 |
| Remote Control | 11 |
| Installing the Batteries | 12 |
| Remote Control Operation | 13 |
| Installation | 14 |
| Connecting the Projector | 14 |
| Powering On/Off the Projector | 15 |
| Adjusting the Projector | 16 |
| Menu Operation | 18 |
| Network Control | 25 |
| Maintenance | 40 |
| Cleaning the Lens | 40 |
| Cleaning the Projector Housing | 40 |
| Cleaning the Filter Cover | 40 |
| Replacing the Lamp | 41 |
| Specifications | 43 |
| Appendix | 44 |
| LED Indicator Messages | 44 |
| Compatibility Modes | 45 |
| Troubleshooting | 47 |
| RS-232 Command and Configuration | 48 |
| IR Control Code | 50 |

Introduction

Projector Features

The projector integrates high-performance optical engine projection and a user - friendly design to deliver high reliability and ease of use.

The projector offers the following features:

- Single chip 1.651cm / 0.65" Texas Instruments DLP® technology
- WXGA (1280 x 800 pixels)
- Auto image re-sizing (Auto-Sync.) to 1280 x 800 full screen with scaling compression compatibility for VGA, SVGA, XGA, SXGA and WXGA
- Compatibility with Macintosh® computers
- Compatibility with NTSC, PAL, SECAM and HDTV
- D-Sub 15-pin terminal for analog video connectivity
- User-friendly, multi-language on-screen display
- Advanced electronic keystone correction
- RS-232 connector for serial control
- RJ-45 connector for networked control



- *The information in this manual is subject to change without notices.*
- *The reproduction, transfer or copy of all or any part of this document is not permitted without express written consent.*

Package Contents

When you unpack the projector, make sure you have all these components:

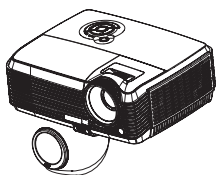

Projector with Lens Cap

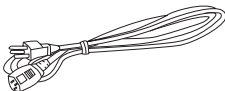

AC Power Cord



Remote Control (IR) & batteries

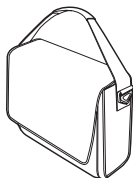

Projector Carrying Case

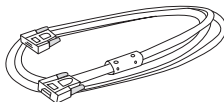

VGA Cable (D-SUB to D-SUB)

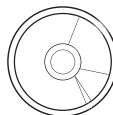

ViewSonic CD Wizard



Quick Start Guide

Optional accessories



RS232 cable
P/N: J2552-0208-00

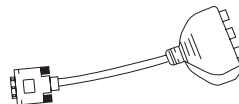

RGB to component adapter
P/N: J2552-0212-00

NOTE

- Contact your dealer immediately if any items are missing, appear damaged, or if the unit does not work.
- Save the original shipping carton and Packing material; they will come in handy if you ever have to ship your unit. For maximum protection, repack your unit as it was originally packed at the factory.

Projector Overview

Front View

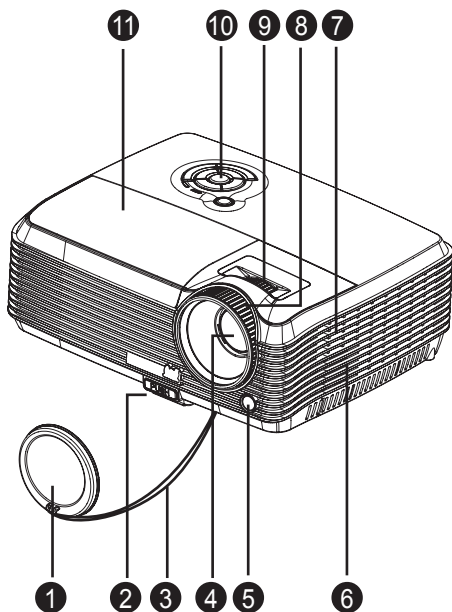

- | | |
|----------------------------------|-----------------|
| ① Lens cap | ⑦ Speaker |
| ② Elevator button | ⑧ Focus ring |
| ③ Lens cap strap | ⑨ Zoom ring |
| ④ Projection lens | ⑩ Control panel |
| ⑤ Front IR remote control sensor | ⑪ Lamp cover |
| ⑥ Ventilation holes (intake) | |

Rear View

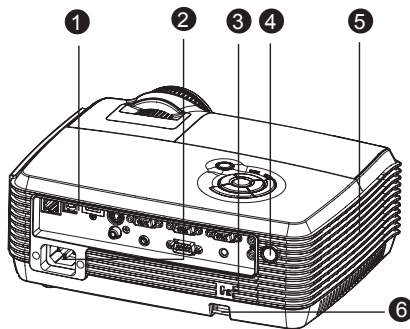

- ❶ Connection ports
- ❷ AC power socket
- ❸ Kensington lock
- ❹ Rear IR remote control sensor
- ❺ Ventilation holes (exhaust)
- ❻ Security bar

Bottom View

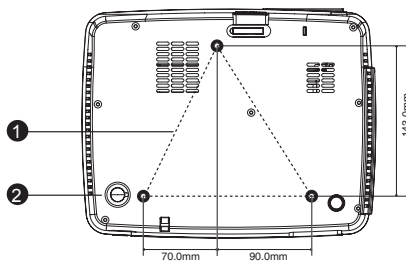

- ❶ Ceiling mount (M4*6)
- ❷ Tilt-adjustment feet





- *This projector can be used with a ceiling mount for support. The ceiling mount is not included in the package.*
- *Contact your dealer for information to mount the projector on a ceiling.*

Using the Product

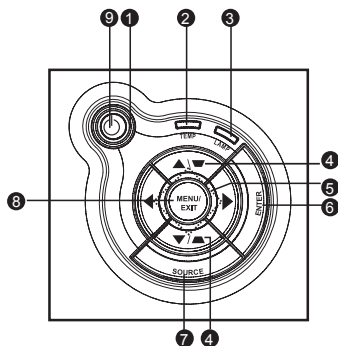

Control Panel

LED



- 1  **Power** (Power LED indicator)
Refer to “LED Indicator Messages”.
- 2 **TEMP** (Temperature LED indicator)
Refer to “LED Indicator Messages”.
- 3 **LAMP** (Lamp LED indicator)
Refer to “LED Indicator Messages”.

Button Function

- 4  **Keystone**
Manually correct distorted images resulting from an angled projection.
- 5 **Four directional buttons**
Use four directional buttons to select items or make adjustments to your selection.
- 6 **ENTER**
Enter to sub-menu and confirm the menu selection.
- 7 **SOURCE**
Manually select an input source.
- 8 **MENU/EXIT**
Display or exit the on-screen display menus.
- 9  **Power**
Turn the projector on or off.

Connection Ports

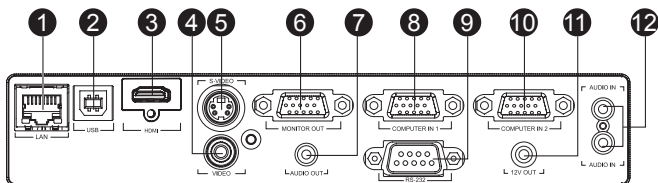

- 1 **LAN**
For network control.
- 2 **USB**
This connector is for firmware update and mouse function support.
- 3 **HDMI**
Connect HDMI output from video equipment to this jack.
- 4 **VIDEO**
Connect composite video output from video equipment to this jack.
- 5 **S-VIDEO**
Connect S-Video output from video equipment to this jack.
- 6 **MONITOR OUT**
Connect to a computer display, etc.
- 7 **AUDIO OUT**
Connect to a speaker or other audio input equipment.
- 8 **COMPUTER IN 1**
Connect image input signal (analog RGB or component) to this jack.
- 9 **RS-232**
When operating the projector via a computer, connect this to the controlling computer's RS-232C port.
- 10 **COMPUTER IN 2**
Connect image input signal (analog RGB or component) to this jack.
- 11 **12V OUT**
12V DC out
- 12 **AUDIO IN**
Connect an audio output from video equipment to this jack. The upper AUDIO IN is Audio 1, and the lower one is Audio 2. When Audio 1 is turned on, Audio 2 will turn off automatically and vice versa.

Remote Control

- 1 POWER**
Turn the projector on or off.
- 2 VGA1**
Select analog RGB signal from COMPUTER IN 1 terminal.
- 3 Source**
Manually select an input source by sequence.
- 4 Enter**
Confirmed selections.
- 5 Keystone+ / -**
Adjust image distortion caused by tilting the projector.
- 6 ViewM**
Switch in between high brightness performance or Accuracy color performance.

- 7 Freeze**
Press "Freeze" to pause the screen image. Press again to cancel the freeze function.
- 8 Mouse**
Switch between OSD control and Mouse control (Apply to Navigation buttons, Enter/Mouse Left Click, and Exit/Mouse Right Click buttons).

- 9 Laser**
Aim the remote at the viewing screen, press and hold this button to activate the laser pointer.

- 10 VGA2**
Select analog RGB signal from COMPUTER IN 2 terminal.

- 11 Video**
Select video signal from video equipment.

- 12 Auto**
Resynchronize the projector to the input signal from a computer. This function is available for computer mode only.

- 13 MENU**
Display on-screen display menus.

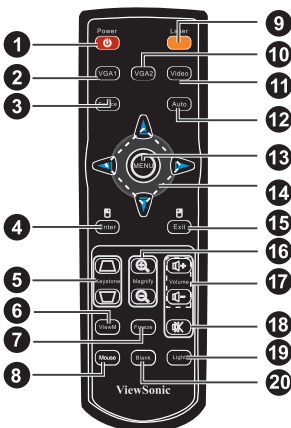

- 14 Four directional buttons**
Use four directional buttons to select items or make adjustment to your selection.

- 15 Exit**
Exit OSD Menu.

- 16 Magnify**
Zoom in and out the images.

- 17 Volume + / -**
Adjust the volume level.

- 18 Mute**
Cut off the sound temporarily. Press again to cancel the Mute function.

- 19 Light**
Enable backlight functions of the remote control's buttons.

- 20 Blank**
Cut off the screen temporarily. Press again to cancel the Blank Screen function.

Installing the Batteries

1. Open the battery cover in the direction shown.

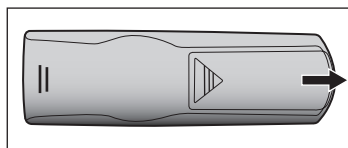

2. Install batteries as indicated by the diagram inside the compartment.

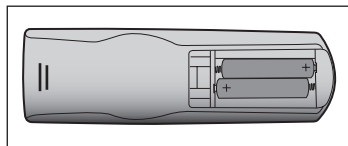

3. Close the battery cover into position.

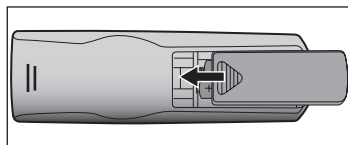

Caution

- Risk of explosion if battery is replaced by an incorrect type.
- Dispose of used batteries according to the instructions.
- Make sure the plus and minus terminals are correctly aligned when loading a battery.



NOTE

- *Keep the batteries out of the reach of children. There is a danger of death by accidentally swallowing the batteries.*
- *Remove batteries from remote control when not using for extended periods.*
- *Do not dispose of the used batteries along with household waste. Dispose of used batteries according to local regulations.*
- *Danger of explosion may happen if batteries are incorrectly replaced. Replace all the batteries with new ones.*
- *Batteries should not be in or near to fire or water, keep batteries in a dark, cool and dry place.*
- *If suspect battery leakage, wipe out the leakage and then replace new batteries. If the leakage adheres to your body or clothes, rinse well with water immediately.*

Remote Control Operation

Point the remote control at the infrared remote sensor and press a button.

- Operating the projector from the front

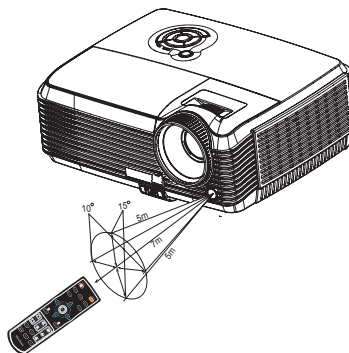

- Operating the projector from the rear

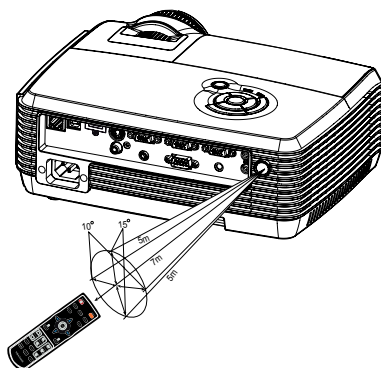

- Do not point the laser directly to the people's eyes (especially small children). There is a danger of injury to the eyes.
- The remote control may not operate when there is sunlight or other strong light such as a fluorescent lamp shining on the remote sensor.
- Operate the remote control from a position where the remote sensor is visible.
- Do not drop the remote control or jolt it.
- Keep the remote control out of locations with excessively high temperature or humidity.
- Do not get water on the remote control or place wet objects on it.
- Do not disassemble the remote control.

Installation

Connecting the Projector

- 1 USB Cable
- 2 VGA Cable (D-Sub to D-Sub)
- 3 RS-232 Cable
- 4 Audio Cable
- 5 VGA (D-Sub) to HDTV (RCA) Cable
- 6 Composite Video Cable
- 7 S-Video Cable
- 8 Internet Cable
- 9 HDMI Cable

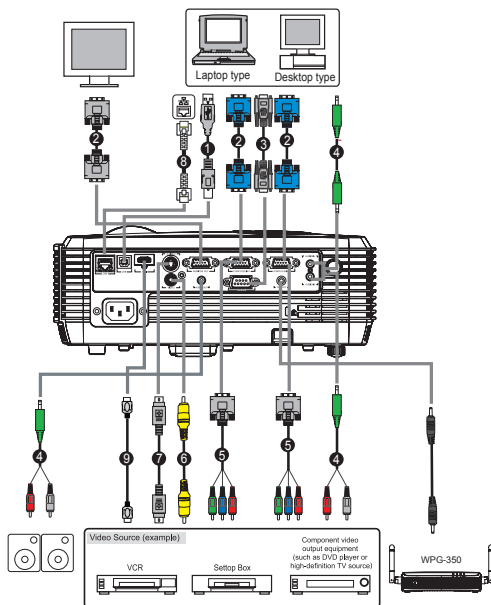

NOTE

- When connecting cable, power cords of both projector and external equipment should be disconnected from AC outlet.
- The figure above is a sample connection. This does not mean that all of these devices can or must be connected simultaneously.
- The cables that come with the projector may differ from the above illustration. The included cables are based on actual shipment delivery.

Powering On/Off the Projector

Powering On the Projector:



1. Remove the projector lens cap.
2. Complete the AC power cord and peripheral signal cable(s) connections.
3. Press  button to turn on the projector.
The projector takes a minute or so to warm up.
4. Turn on your source (computer, notebook, DVD, etc.). The projector automatically detects your source.
 - If you are connecting multiple sources to the projector simultaneously, press the **SOURCE** button on the control panel or the Source button on the remote control.



Warning

- Remove the lens cap first before powering on.
- Never look into the lens when the lamp is on. This can damage your eyes.
- This focal point concentrates high temperature. Do not place any object near it to avoid possible fire hazard.

Powering Off the Projector:

1. Press  button to turn off the projector lamp. You will see a message "Power off? Press Power again" appear on the screen.
2. Press  button again to confirm.
 - The cooling fans continue to operate for cooling cycle.
 - When the Lamp LED begins flashing, the projector has entered stand-by mode.
 - If you want to turn the projector back on, you must wait until the projector has completed the cooling cycle and has entered stand-by mode. Once in stand-by mode, simply press  button to restart the projector.
3. Disconnect the AC power cord from the electrical outlet and the projector.
4. Do not turn on the projector right after power off.

Adjusting the Projector

Adjusting the Projector Height

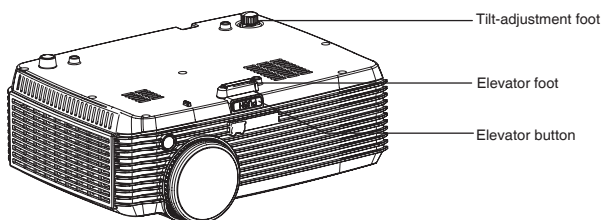

The projector is equipped with an elevator foot to adjust the image height.

To raise or lower the image:

1. To raise or lower the image, press the elevator button and raise or lower the front of the projector. Release the button to lock the adjustment.
2. To level the image on the screen, turn the tilt-adjustment foot to fine-tune the height.

NOTE

- To avoid damaging the projector, make sure that the elevator foot and tilt-adjustment foot are fully retracted before placing the projector in its carrying case.

Adjusting the Projector Zoom and Focus

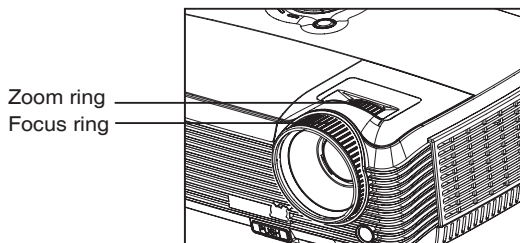

1. Focus the image by rotating the focus ring. A still image is recommended for focusing.
2. Adjust the image by sliding the zoom ring.

Adjusting Projection Image Size

Refer to the graphic and table below to determine the screen size and projection distance.

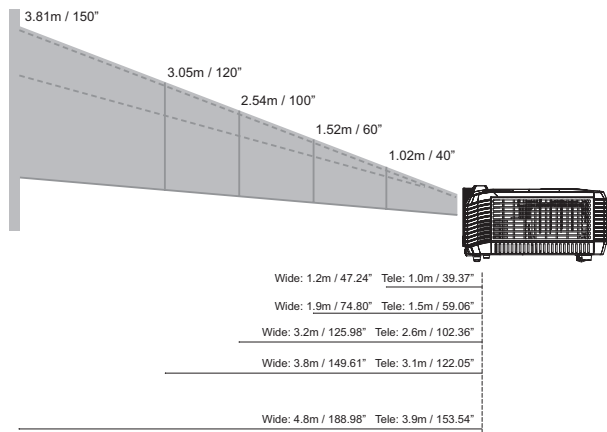

| Screen size Diagonal | 16 : 10 Screen | | | |
|-------------------------|---------------------|-------|---------------------|-------|
| | Wide | | Tele | |
| | Projection distance | | Projection distance | |
| | m | inch | m | inch |
| 1.02m / 40" | 1.23 | 48.6 | 1.01 | 39.7 |
| 1.27m / 50" | 1.56 | 61.3 | 1.27 | 50.0 |
| 1.52m / 60" | 1.88 | 74.0 | 1.53 | 60.3 |
| 1.78m / 70" | 2.20 | 86.6 | 1.80 | 70.7 |
| 2.03m / 80" | 2.52 | 99.3 | 2.06 | 81.0 |
| 2.29m / 90" | 2.84 | 112.0 | 2.32 | 91.4 |
| 2.54m / 100" | 3.17 | 124.7 | 2.58 | 101.7 |
| 3.05m / 120" | 3.81 | 150.0 | 3.11 | 122.4 |
| 3.81m / 150" | 4.78 | 188.1 | 3.90 | 153.4 |

NOTE

- Position the projector in a horizontal position; other positions can cause heat build-up and damage to the projector.
- Keep a space of 30 cm or more between the sides of the projector.
- Do not use the projector in a smoky environment. Smoke residue may build-up on critical parts and damage the projector or its performance.
- Consult with your dealer for special installation such as suspending from a ceiling.

Menu Operation

The projector has multilingual on-screen display menus that allow you to make image adjustments and change a variety of settings.

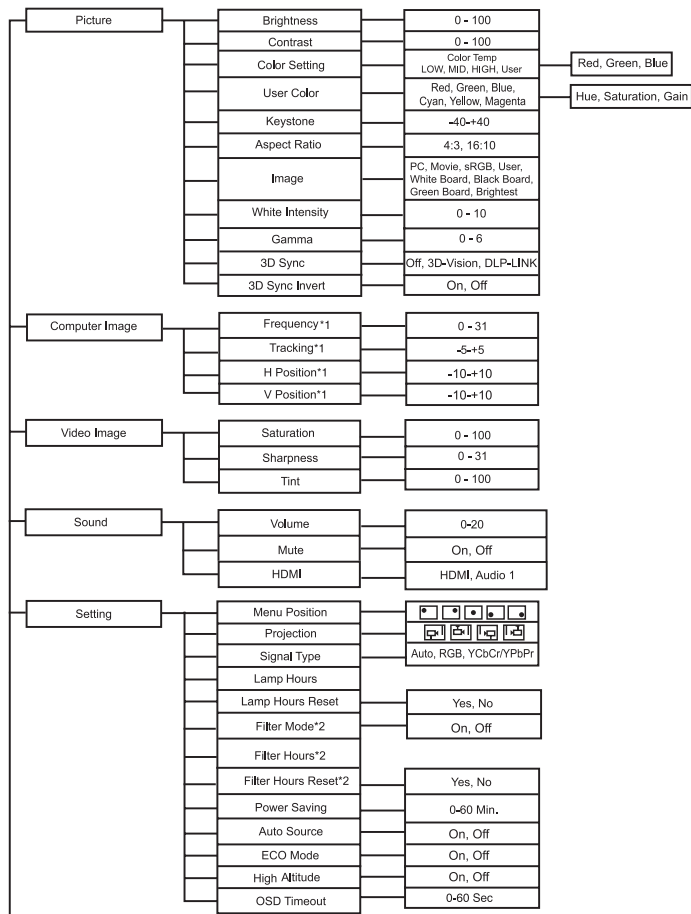

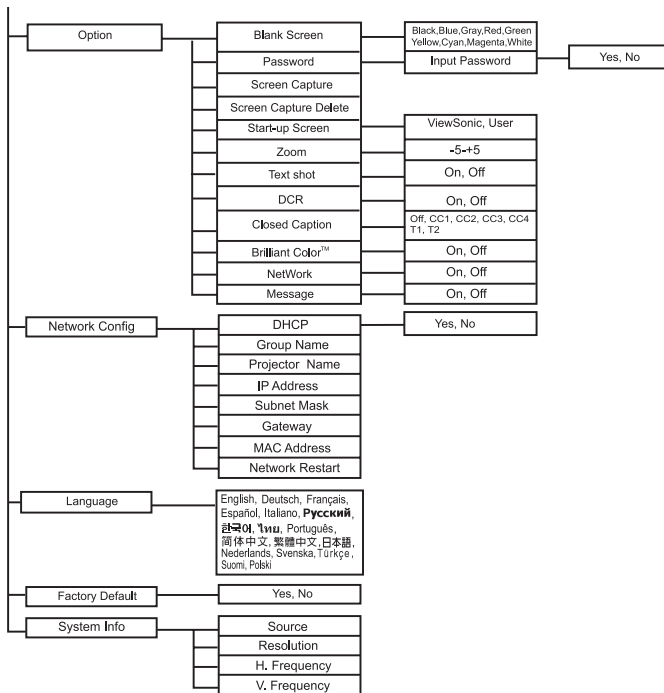

*1 Adjustable range and default setting vary depending on signal type.

*2 This function is only available when the projector is installed an optional filter cover.

How to operate

1. Press the **MENU** button to open the OSD menu.
2. When OSD is displayed, use **▲ / ▼** to select any feature in the main menu.
3. After selecting the desired main menu item, press **▶** to enter sub-menu for feature setting.
4. Use **▲ / ▼** to select the desired item and adjust the settings with **◀ / ▶**.
5. Press the **MENU** button, the screen will return to the main menu.
6. To exit OSD, Press the **MENU** button again. The OSD menu will close and the projector will automatically save the new settings.

Picture (Computer / Video Mode)

Brightness

Brighten or darken the image.

Contrast

Set the difference between light and dark areas.

Color Setting

Adjust the color temperature. At higher temperature the screen looks colder; at lower temperature, the screen looks warmer. If you select "User", then you can change the intensity of each of 3 color (Red, Green, Blue) to customize user color temperature.

User Color

User Color provides six sets (RGBCMY) of colors to be adjusted. When you select each color, you can independently adjust its range and saturation according to your preference.

Keystone

Manually correct distorted images resulting from an angled projection.

Aspect Ratio

Select how the picture fits on the screen:

- 4:3 : The input source will be scaled to fit the projection screen.
- 16:10 : The input source will be scaled to fit the width of the screen.

Image

There are many factory presets optimized for various types of images.

- PC : For computer or notebook.
- Movie : For home theater.
- sRGB : For PC standard color.
- User : Memorize user's settings.
- White Board : For white projection screen type.
- Black Board : For black projection screen type.
- Green Board : For green projection screen type.
- Brightest : For a bright environment.

White Intensity

Increase the brightness of white areas.

Gamma

Effect the represent of dark scenery. With greater gamma value, dark scenery will look brighter.

3D Sync

- Off: Disable 3D function
- 3D-Vision: For NVIDIA 3D Vision application
- DLP-LINK: For TI 3D DLP-LINK application

3D Sync Invert (for TI 3D DLP-LINK only)

- On: Invert left and right frame contents.
- Off: Default frame contents.

Computer Image (Computer Mode)

Frequency

Adjust the timing of the projector relative to the computer.

Tracking

Adjust the phase of the projector relative to the computer.

H Position (Horizontal Position)

Adjust the image left or right within the projection area.

V Position (Vertical Position)

Adjust the image up or down within the projection area.

Video Image (Video Mode)

Saturation

Adjust a video image from black and white to fully saturated color.

Sharpness

Sharpen or soften the image.

Tint

Shift colors toward red or green.

Sound (Computer / Video Mode)

Volume

Adjust the volume level.

Mute

Cut off the sound temporarily.

HDMI

This feature is only available for HDMI input signal. When the input source is HDMI, user can manually switch the sound source to HDMI or Audio 1.

Setting (Computer / Video Mode)

Menu Position

Choose the menu location on the display screen.

Projection

Adjust the picture to match the orientation of the projector: upright or upside-down, in front of or behind the screen. Invert or reverse the image accordingly.

Signal Type

Specify the source to the COMPUTER IN 1/COMPUTER IN 2 terminal that you wish to project.

- **Auto** : Automatically detect the input signal type from COMPUTER IN 1 and COMPUTER IN 2 terminals.
- **RGB** : For VGA signal
- **YCbCr/YPbPr**:For component signal

Lamp Hours

Display the lamp's elapsed operating time (in hours).

Lamp Hours Reset

Reset the lamp Hour to 0 hours.

Filter Mode

Use this function to activate filter mode after the projector is installed an optional filter cover.

Filter Hours

Display the filter's elapsed operating time (in hours).

- When Filter Mode is turned on, the Filter Hours also turns on automatically.

Filter Hours Reset

Reset the filter Hour to 0 hours.

Power Saving

If no operation is performed for a specific period of time, projector will automatically turn off.

Auto Source

Automatically scan through all the input source.

ECO Mode

Use this function to dim the projector lamp light output which will lower power consumption and increase lamp life.

- This function will be unavailable when the DCR function is on.

High Altitude

Use this function to allow the fans operates at full speed continuously to achieve proper high altitude cooling of the projector.

OSD Timeout

Duration of OSD menu display countly starts (at idle state by second).

Option (Computer / Video Mode)

Blank Screen

Blank the screen temporarily, and select the screen color when this function is active.

Password

Set or change the password. When the password function is added, image projection will require to input the preset password when turning on the projector.

Screen Capture

Capture the current projection screen as a start-up screen.

Screen Capture Delete

Delete the captured projection screen.

Start-up Screen

Select start-up screen when the projector is powered on or when no signal is input. "User" is the screen that you captured.

Zoom

Zoom in and out the images.

Text shot

Using command codes, text messages can be sent for display by the projector over a network connection. Text is shown on the center of the projection screen. This is a great way to display urgent alert messages to employees, and simply requires a connection to the projector's LAN connector.

DCR (Dynamic Contrast Ratio)

Enable DCR will further enhance contrast ratio by darkening the black scenes. Disable DCR will resume to normal contrast performance. DCR will impact lamp life and system noise performance.

Closed Caption

Enable or Disable closed captions by selecting CC1 (closed caption1, the most common channel), CC2, CC3, CC4, T1, T2 or OFF.

Brilliant Color™

Produce an expanded on-screen color spectrum that delivers enhanced color saturation for bright, true-to-life images. Suggesting to turn Off for most video sources and On for most computer sources.

NetWork

Enable or disable network management via RJ45 connector.

Message

Enable or disable the message box at the right bottom of the screen.

Network Config (Computer / Video Mode)

DHCP

Abbreviation for Dynamic Host Configuration Protocol. This protocol automatically assigns IP Address to networked devices.

- When the "DHCP" sets to "Yes", it takes some time to obtain IP address from DHCP server.
- When the "DHCP" sets to "No", that means user will set IP address by manually.

Group Name

Display group name.

Projector Name

Display projector name.

IP Address

Numerical address to identify networked computers. This function can only be used when DHCP is set to No.

- The IP Address is the number that identifies this projector on the network. You cannot have two devices with the same IP Address on the same network.
- The IP Address "0.0.0.0" is prohibited.

Subnet Mask

A numeric value to define the number of bits used for a network address of a divided network (or subnet) in an IP Address. This function can only be used when DHCP is set to No.

- The Subnet Mask "0.0.0.0" is prohibited.

Gateway

A server (or router) to communicate across networks (subnets) that are divided by Subnet Mask. This function can only be used when DHCP is set to No.

MAC Address

Abbreviation for Media Access Control Address. MAC Address is a unique ID number assigned to each network adapter.

Network Restart

Restart network function when the device is not working properly or to apply changes made on OSD configuration menu.

Language (Computer / Video Mode)

Select the language used by the on-screen menu.

Factory Default (Computer / Video Mode)

Restore settings to factory default .

System Info (Computer / Video Mode)**Source**

Display the current input source.

Resolution

Display current input source resolution.

H. Frequency

Display current image horizontal frequency.

V. Frequency

Display current image vertical frequency.

Network Control

This feature provides the ability to remotely control and manage the projector through the network.

Preparation:

1. Connect one end of the internet cable to the Network Control connector on the projector.
2. Connect the other end of the internet cable to an available RJ-45 connector on your computer.
3. Turn on your projector and computer.

There are two ways to connect to the network control:

A. Auto IP address setting (DHCP : Yes):

1. Enable DHCP from the projector OSD, under Network Config.
 - When DHCP is enabled, IP Address, Subnet Mask and Gateway information will get from DHCP server automatically.

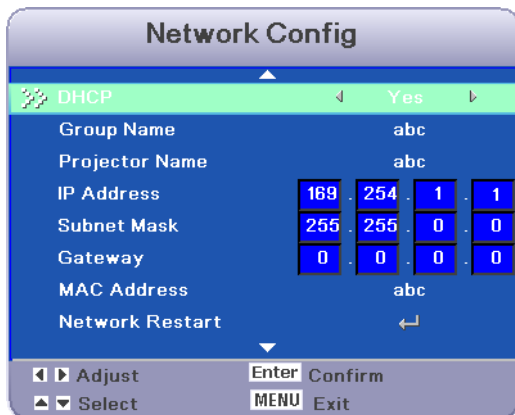

2. Start browser in PC and specify following URL, then click “Go” button.
 - URL: http://(Projector IP address)/
 - For example, if projector IP address is 169.254.1.1, specify URL: http://169.254.1.1/

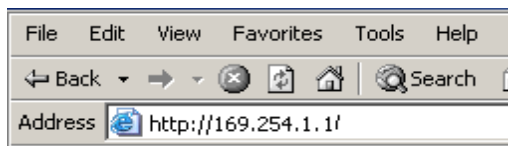

3. If connection succeeds, the login screen is displayed. Enter your User name and Password and click “OK”. Below are the factory default settings for administrator, user and passwords.

| Item | User name | Password |
|---------------|-----------|----------|
| Administrator | Admin | <blank> |
| User | User | <blank> |

 For setting passwords, please go to Network Control page > Password.

B. Manual IP address setting (DHCP: No):

1. Set IP Address and Subnet Mask under Network Config.
 - IP Address: Numerical address to identify networked computers.
 - Subnet Mask: A numeric value to define the number of bits used for a network address of a divided network (or subnet) in an IP Address.
 - Gateway: A server (or router) to communicate across networks (subnets) that are divided by Subnet Mask.

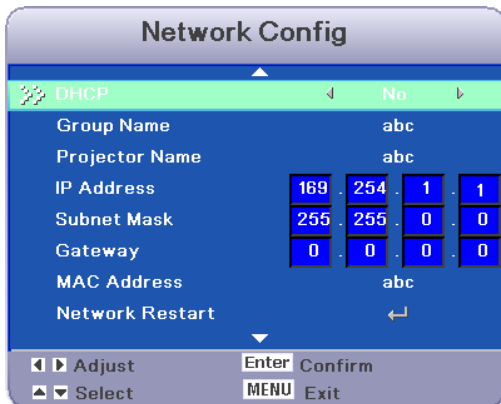

The screenshot shows a 'Network Config' window with a blue background. At the top, 'DHCP' is set to 'No'. Below this, several fields are visible: 'Group Name' (abc), 'Projector Name' (abc), 'IP Address' (189.254.1.1), 'Subnet Mask' (255.255.0.0), 'Gateway' (0.0.0.0), and 'MAC Address' (abc). At the bottom, there are navigation buttons: 'Adjust' (with left and right arrows), 'Select' (with a dropdown arrow), 'Enter Confirm', and 'MENU Exit'.

2. From your computer, go to **Start > Settings > Network and Dial-up Connections > Local Area Connection** and right click to select **Properties**..

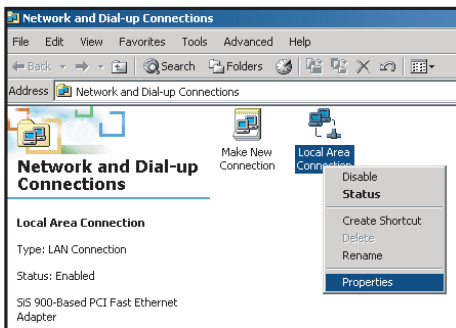

3. Select **"Intel Protocol (TCP/IP)"** and click **"Properties"**.

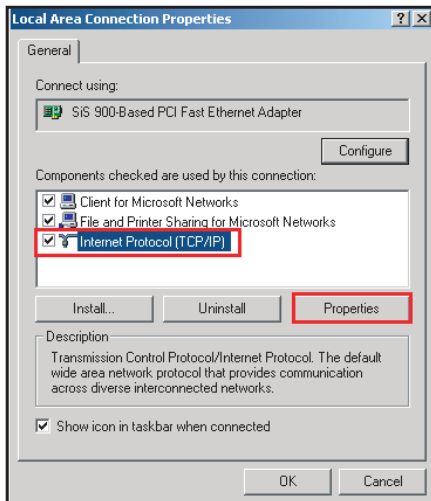

4. Set your PC's IP address, and click **OK**.
- Click **"Use the following IP address"**
 - The network address portion included in the IP address set into your PC should be common with projector's one.
 - In this case, projector has "169.254.1.1" IP address, specify "169.254.1.xxx" for PC's IP address. Select from 1 to 254 for "xxx" except 2 for PC.

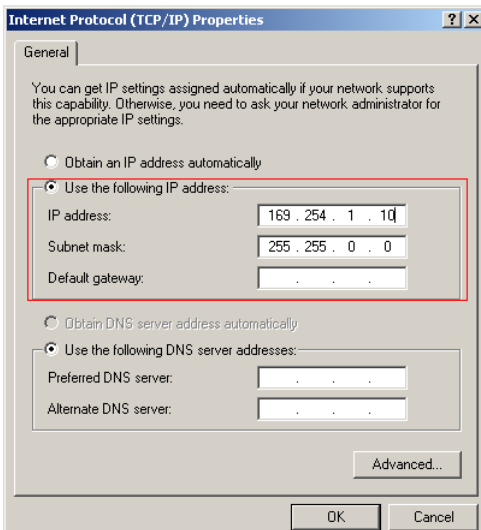

5. Start browser in PC and specify following URL, then click “Go” button.
 - URL: http://(Projector IP address)
 - For example, if projector IP address is 169.254.1.1, specify URL: http://169.254.1.1/.

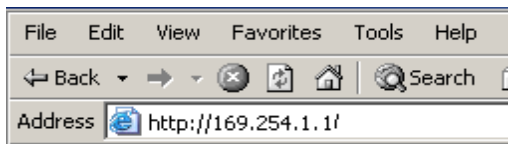

6. If connection succeeds, the login screen is displayed. Enter your User name and Password and click “OK”. Below are the factory default settings for administrator, user and passwords.

| Item | User name | Password |
|---------------|-----------|----------|
| Administrator | Admin | <blank> |
| User | User | <blank> |

☞ For setting passwords, please go to Network Control page > Password.

Control the projector via a web browser

Login

If the administrator and user passwords are disabled, it will directly go into the Status page.

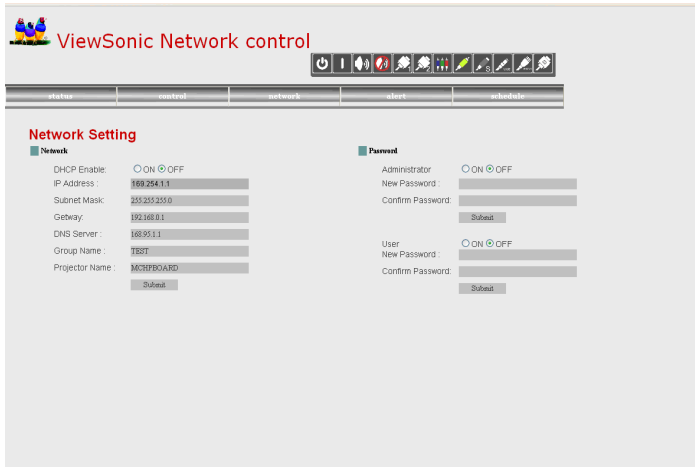

ViewSonic Network control

Navigation: status | control | **network** | alert | schedule

Network Setting

Network

DHCP Enable: ON OFF

IP Address: 169.254.1.1

Subnet Mask: 255.255.255.0

Gateway: 192.168.0.1

DNS Server: 168.95.1.1

Group Name: T307

Projector Name: MICROBOARD

Subnet: Subnet

Password

Administrator ON OFF

New Password: [input]

Confirm Password: [input]

Subnet: Subnet

User ON OFF

New Password: [input]

Confirm Password: [input]

Subnet: Subnet

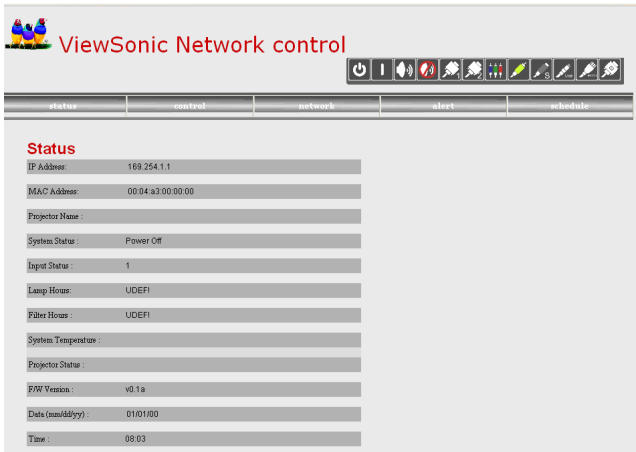

ViewSonic Network control

Navigation: status | control | network | **alert** | schedule

Status

IP Address: 169.254.1.1

MAC Address: 00:04:a3:00:00:00

Projector Name: [input]

System Status: Power Off

Input Status: 1

Lamp Hours: UDEF1

Filament Hours: UDEF1

System Temperature: [input]

Projector Status: [input]

F/W Version: v0.1a

Data (ms:dd:yy): 01/01/00

Time: 00:03

If the Administrator & User passwords are enabled, select your User Name and enter password to login.

Authority on the network control of Administrator & User:

| Item | Description | Administrator | User |
|-----------------|---|----------------------|-------------|
| Status | Show current projector status and network configuration settings. | v | v |
| Control | Control the projector via network. | v | v |
| Network Setting | Network configuration & Password setup. | v | x |
| Alert | Show and setup Alert configurations. | v | x |
| Schedule | Show and setup Scheduling configurations. | v | v |

Status

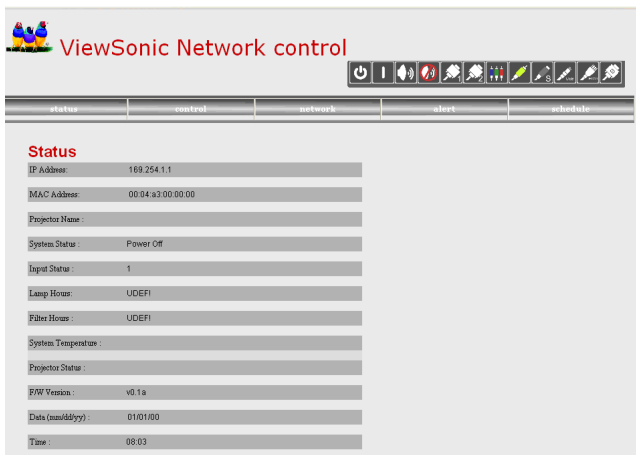

All screen images in this manual are shown when you login with the Administrator ID. The image will differ if you login with User ID.

| Item | Description |
|--------------------|---|
| IP Address | Show current IP address. |
| MAC Address | Show current MAC Address. |
| Projector Name | Show projector name. |
| System Status | Show if projector is Powered ON or Standby. |
| Input Status | Show current input source. |
| Lamp Hours | Show lamp used hours on current projector. |
| Filter Hours | Show filter used hours on current projector. |
| System Temperature | Show system temperature. |
| Projector Status | Show current projector status, either function normally or error found. |
| F/W Version | Show projector's F/W version |
| Date(mm/dd/yy) | Show date set on current projector. |
| Time | Show time set on current projector *. |

Remark:

*If the power has not been supplied for over 50 hours, date and time will be reset.

Control

ViewSonic Network control

Home Control network Alert Schedule

Control

BASIC

Power Switch:

Input Source: COMPUTER1

Date: 2009 12 29

Time: 0 0

Volume: 0

Mute: OFF

Picture

Brightness: 0

Contrast: 0

Color Temperature: High

Keystone: 0

Picture Mode: PC

Aspect Ratio: FILL ALL

Freeze: OFF

Video Image

Color: 0

Tint: 0

Sharpness: 0

Computer Image

Frequency: 0

Tracking: 0

H Position: 0

V Position: 0

Setting

Menu Position: Top Left

Projection: Front/Desk

Auto Source: ON

ECO Mode: OFF

High Altitude: OFF

OSD Timeout: 3

Language: English

Factory Default: NO

Option

ViewMatch: OFF

White Intensity: 0

Gamma: 0

Signal Type: ROB

Filter Mode: OFF

Power Saving: NO

Start UP Screen: ViewSonic

Closed Caption: OFF

Blank Screen: OFF

| Item | Description |
|--------------------|--|
| Basic | |
| Power Switch | Power On or Power Off the projector via network. |
| Input Source | Select input source. |
| Date | Show date set on current projector. |
| Time | Show time set on current projector*. |
| Volume | Adjusts the volume setting. (0 - 20) |
| Mute | Enable or disable the mute function. |
| Picture | |
| Brightness | Adjusts the brightness setting. (0 - 100) |
| Contrast | Adjusts the contrast setting. (0 - 100) |
| Color Temperature | Selects the color temperature setting. |
| Keystone | Adjusts the keystone setting. (-40 - +40) |
| Picture Mode | Selects the picture mode setting. |
| Aspect Ratio | Selects the aspect ratio setting. |
| Freeze | Enable or disable the freeze function. |
| Video Image | |
| Color | Adjusts the color setting. |

| | |
|-----------------------|---|
| Tint | Adjusts the tint setting. (0 - 100) |
| Sharpness | Adjusts the sharpness setting. (0 - 31) |
| Computer Image | |
| Frequency | Adjusts the frequency. (-50 - +50) |
| Tracking | Adjusts the tracking. (0 - 31) |
| H Position | Adjusts the horizontal position. (-10 - +10) |
| V Position | Adjusts the vertical position. (-10 - +10) |
| Setting | |
| Menu Position | Adjusts the menu position. |
| Projection | Selects the projection setting. |
| Auto Source | Enable or disable the auto source function. |
| ECO mode | Enable or disable the ECO function. |
| High Altitude | Enable or disable the high altitude function. |
| OSD Timeout | Selects the OSD timeout setting. |
| Language | Selects preferred OSD language. |
| Factory Default | Enable or Disable factory default. |
| Option | |
| ViewMatch | Selects ViewMatch setting. |
| White Intensity | Adjusts white intensity setting. |
| Gamma | Adjusts gamma setting. |
| Signal Type | Selects signal type setting. |
| Filter Mode | Selects filter mode setting. |
| Power Saving | Selects power saving setting. |
| Start Up Screen | Selects start-up screen setting. |
| Closed Caption | Selects closed caption setting. |
| Blank Screen | Selects blank screen setting. |

Remark:

*If the power has not been supplied for over 50 hours, date and time will be reset.



■ *If the adjustment did not display properly. Please "refresh" or "reload" the browser again.*

Network Setting

ViewSonic Network control

Network Setting

Network

DHCP Enable: ON OFF

IP Address:

Subnet Mask:

Gateway:

DNS Server:

Group Name:

Projector Name:

Password

Administrator: ON OFF

New Password:

Confirm Password:

User: ON OFF

New Password:

Confirm Password:

| Item | Description |
|------------------|---|
| Network | |
| DHCP | Assign an IP address to the projector from the DHCP server automatically or manually. |
| IP Address | Setup IP address when DHCP is disable. |
| Subnet Mask | Setup subnet mask when DHCP is disable. |
| Gateway | Setup gateway when DHCP is disable. |
| DNS Server | Setup DNS server address when DHCP is disable. |
| Group Name | Create projector group. (Max length: 6 characters) |
| Projector Name | Create projector naming of the current projector. (Max length: 15 characters) |
| Password | |
| Administrator | Enable or disable administrative password function. |
| New Password | Setup administrative password. (Max length: 4 characters) |
| Confirm Password | Re-enter administrative password. |
| User | Enable or disable user password function. |
| New Password | Setup user password. (Max length: 4 characters) |
| Confirm Password | Re-enter user password. |

Click "Submit" button to save the settings.

Alert

ViewSonic Network control

Alert

Email Setting

To: james666@hotmail.com

CC: jameschao@gmail.com

Subject: TEST123

From: james@vrf.com.tr

Server: 60.248.43.19

User Name: james

Password: *****

Submit

Issue Test Mail

Alert Condition

Fan Lock

Over Temperature

Lamp Fail

Lamp Time Alert

Schedule Execution Error

Filter Time Alert

Submit

| Item | Description |
|--------------------------|--|
| Email Setting | |
| To | Setup the mail alert attendee. (Max length: 40 characters) |
| Cc | Setup the backup mail alert attendee. (Max length: 40 characters) |
| Subject | Setup the subject of the alert e-mail. (Max length: 30 characters) |
| From | Setup the sender e-mail address. (Max length: 40 characters) |
| Server | To enter the SMTP server (Mail server) name of the company. For example: mail.viewsonic.com (Max length: 30 characters) |
| User Name | Enter user name of the sender's e-mail account. (Max length: 20 characters) |
| Password | Enter password of the sender's e-mail account. (Max length: 14 characters) |
| Alert Condition | |
| Fan Lock | The cooling fan is not operating. |
| Over Temperature | The projector internal is over heated. |
| Lamp Fail | The lamp does not light up. |
| Lamp Time Alert | Lamp is approaching the end of its useful life in full power operation. Replacement is suggested. |
| Schedule Execution Error | Schedule Execution Error. |
| Filter Time Alert | Filter is approaching the end of its useful life. Replacement is suggested. |

Click "Submit" button to save the settings, then click "Issue Test Mail" to send a test mail to check whether all settings and functions are correct.

Schedule

The schedule function is divided into two scheduling categories, as shown below:
Weekly Schedule: defines the date of each week will execute the command

The screenshot shows the 'ViewSonic Network control' interface with the 'Schedule' tab selected. The 'Weekly Day' option is active. The configuration shows 'Power On Time' set to 'Sunday' at '0:00' and 'Power Off Time' set to '0:00'. The 'Input Source' is set to 'ROBI'. An 'Add' button is visible. Below the configuration is a table with 6 rows and 5 columns: No., Week, Power ON, Power OFF, Input Source, and Cancel.

| No. | Week | Power ON | Power OFF | Input Source | Cancel |
|-----|------|----------|-----------|--------------|------------|
| 1 | Fri | 10:17 | 16:15 | 1 | - cancel - |
| 2 | | | | | - cancel - |
| 3 | | | | | - cancel - |
| 4 | | | | | - cancel - |
| 5 | | | | | - cancel - |
| 6 | | | | | - cancel - |

Click "Add" button to create new schedule. To delete schedule, click "Cancel". Specific Day: defines the month and day that will execute the command.

The screenshot shows the 'ViewSonic Network control' interface with the 'Schedule' tab selected. The 'Specific Day' option is active. The configuration shows 'Power On Time' set to '2008 / 5 / 29' at '0:00' and 'Power Off Time' set to '2008 / 5 / 29' at '0:00'. The 'Input Source' is set to 'ROBI'. A 'Submit' button is visible. Below the configuration is a table with 6 rows and 5 columns: No., Power On, Power Off, Input Source, and Cancel.

| No. | Power On | Power Off | Input Source | Cancel |
|-----|----------|-----------|--------------|------------|
| 1 | | | | - Submit - |
| 2 | | | | - Submit - |
| 3 | | | | - Submit - |
| 4 | | | | - Submit - |
| 5 | | | | - Submit - |
| 6 | | | | - Submit - |

Click "Submit" button to create new schedule. To delete schedule, click "Cancel".

Tips for solving web page problems:

If your web page is not running smoothly, please follow below steps to set the browser.

1. Go to Tools > General and click "Settings".

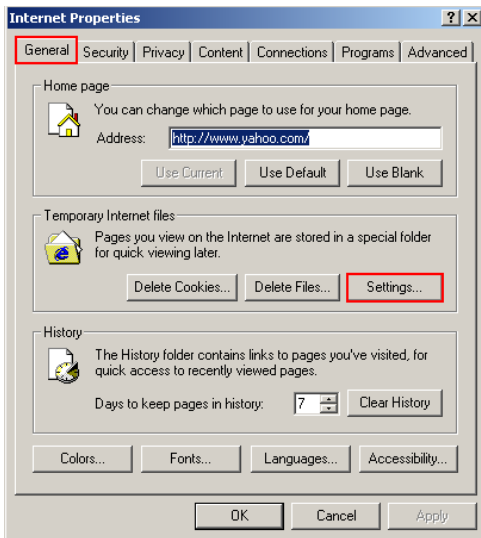

- Click "Every visit to the page" and "OK".

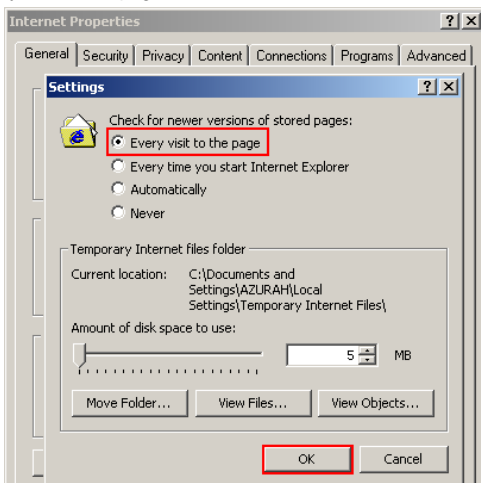

- Click "OK" to exit "Internet Properties".

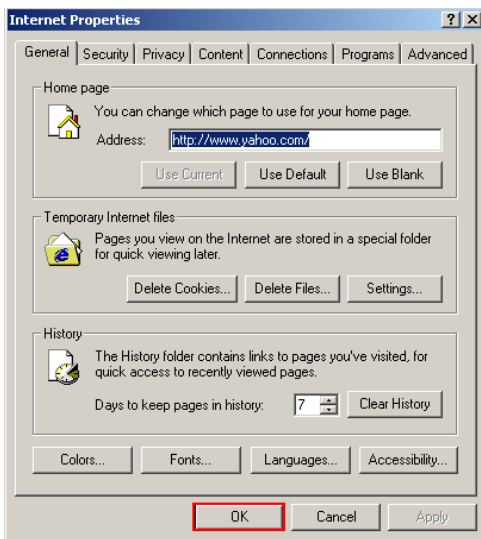

Maintenance

The projector needs proper maintenance. You should keep the lens clean as dust, dirt or spots will project on the screen and diminish image quality. If any other parts need replacing, contact your dealer or qualified service personnel. When cleaning any part of the projector, always switch off and unplug the projector first.



Warning

Never open any of the covers on the projector. Dangerous electrical voltages inside the projector can cause severe injury. Do not attempt to service this product yourself. Refer all servicing to qualified service personnel.

Cleaning the Lens

Gently wipe the lens with lens cleaning paper. Do not touch the lens with your hands.

Cleaning the Projector Housing

Gently wipe with a soft cloth. If dirt and stains are not easily removed, use a soft cloth dampened with water, or water and neutral detergent, and wipe dry with a soft, dry cloth.



- Turn off the projector and remove the AC power cord from the power outlet before beginning maintenance work.
- Make sure the lens is cool before cleaning.
- Do not use detergents or chemicals other than those noted above. Do not use benzene or thinners.
- Do not use chemical sprays.
- Use a soft cloth or lens paper only.

Replacing the Lamp

As the projector operates over time, the brightness of the projector lamp gradually decreases and the lamp becomes more susceptible to breakage. We recommend replacing the lamp if a warning message is displayed. Do not attempt to replace the lamp yourself. Contact the qualified service personnel for replacement.



- *The lamp is extremely hot right after turning off the projector. If you touch the lamp, you may scald your finger. When you replace the lamp, wait for at least 45 minutes for the lamp to cool down.*
- *Do not touch the lamp glass at any time. The lamp may explode due to improper handling, including the touching of the lamp glass.*
- *Lamp lifetime may differ from lamp to lamp and according to the environment of use. There is no guarantee of the same lifetime for each lamp. Some lamps may fail or terminate their lifetime in a shorter period of time than other similar lamps.*
- *A lamp may explode as a result of vibration, shock or degradation as a result of hours of use as its lifetime draws to an end. Risk of explosion may differ according to the environment or conditions in which the projector and lamp are being used.*
- *Wear protective gloves and eyeglasses when fixing or detaching the lamp.*
- *Faster on-off-cycles will damage the lamp and reduce lamp life. Wait at least for 5 minutes to turn off the projector after powering on.*
- *Do not operate the lamp in proximity to paper, cloth, or other combustible material nor cover it with such materials.*
- *Do not operate the lamp in an atmosphere containing an inflammable substance, such as thinner.*
- *Thoroughly ventilate the area or the room when operating the lamp in an oxygen atmosphere (in the air). If ozone is inhaled, it could cause headaches, nausea, dizziness, and other symptoms.*
- *The inorganic mercury is involved in the lamp. If the lamp bursts, the mercury inside the lamp will be exposed. Leave the area immediately if the lamp shatters while being operated and ventilate the area for at least 30 minutes in order to avoid the inhalation of mercury fumes. Otherwise it could be harmful to user's health.*

1. Turn off the projector.
2. If the projector is installed in a ceiling mount, remove it
3. Unplug the power cord.
4. Loosen the screw in the side of the lamp cover and remove the cover.
5. Remove the screws from the lamp module, raise the handle, and lift out the module.
6. Insert the new lamp module into the projector and tighten the screws.
7. Replace the lamp cover and tighten the screw.
8. Turn on the projector. If the lamp does not turn on after the warm-up period, try reinstalling the lamp.
9. Reset the lamp hour. Refer to the “Setting” menu.

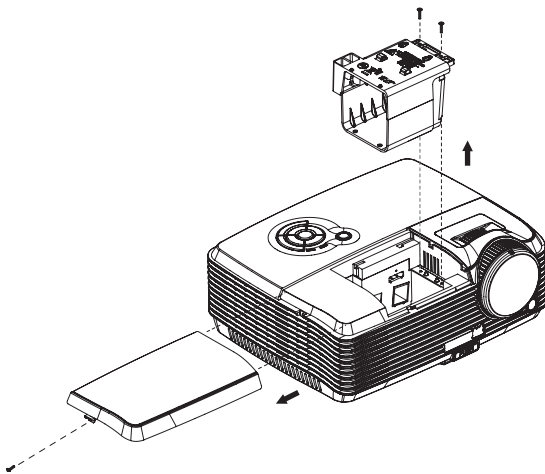

NOTE

- *Dispose the used lamp according to local regulations.*
- *Ensure that screws are tightened properly. Screws not tightened fully may result in injury or accidents.*
- *Since the lamp is made of glass, do not drop the unit and do not scratch the glass.*
- *Do not reuse the old lamp. This could cause the lamp to explode.*
- *Be sure to turn off the projector and unplug the AC power cord before replacing the lamp.*
- *Do not use the projector with the lamp cover removed.*

Specifications

| | |
|---|--|
| Display system | Single 1.651cm / 0.65" DLP panel |
| Resolution | WXGA (1280 x 800) |
| Zoom | 1.2X |
| F/No. | 2.55 |
| Focal length | 21 - 25.6mm |
| Screen size | 101.6cm ~ 381cm / 40" – 150" |
| Lamp | 230W |
| Input terminal | D-Sub 15-pin x 2, S-VIDEO x 1, VIDEO x 1, Audio signal input (3.5 mm stereo mini jack) x 2, HDMI x 1 |
| Output terminal | D-Sub 15 pin x 1, Audio signal output (3.5 mm stereo mini jack) x 1, 12-Vdc trigger output x 1 |
| Control terminal | RS-232 x 1, USB x 1, LAN x 1 |
| Speaker | 5 watt x 2 |
| Video compatibility | NTSC, NTSC 4.43 PAL, PAL-N, PAL M SECAM, HDTV (480p, 576p, 720p, 1080i/p), Composite video |
| Scanning frequency | 31 - 80 KHz 50 - 120 Hz |
| Horizontal frequency | |
| Vertical frequency | |
| Environment | Operating: Temperature: 0°C to 40°C Humidity: 30%-85% Storage: Temperature: -20°C to 60°C Humidity: 30%-85% |
| Power requirement | AC 100-240 V, 50 - 60 Hz, 3.7A |
| Power consumption | 290 W |
| Dimension (W x D x H) | 279.5 x 218 x 105 mm (11.0 x 8.6 x 4.1 inches) |
| Weight | 2.7 kg (6lb) |
| Note: Design and Specifications are subject to change without prior notice. | |

Appendix

LED Indicator Messages

| LED Type | Color | Status | Meaning |
|-----------|-------|-------------------------|---|
| Power LED | Blue | Solid | The projector is in standby mode. |
| Lamp LED | Off | Off | |
| Temp LED | Off | Off | |
| Power LED | Blue | Solid | Powering up |
| Lamp LED | Off | Off | |
| Temp LED | Off | Off | |
| Power LED | Blue | Solid | Normal operation |
| Lamp LED | Off | Off | |
| Temp LED | Off | Off | |
| Power LED | Blue | Flash | Power-down |
| Lamp LED | Off | Off | |
| Temp LED | Off | Off | |
| Power LED | Blue | Solid (Full brightness) | The projector system has some problems with its fans, so the projector cannot start up. |
| Lamp LED | Red | Solid | |
| Temp LED | Red | Flash | |
| Power LED | Blue | Solid (Full brightness) | The lamp is in good condition and is projecting at maximum brightness. |
| Lamp LED | Off | Off | |
| Temp LED | Off | Off | |
| Power LED | Blue | Solid (Full brightness) | The lamp has reached its end of life and must be changed soon. The lamp will continue to operate until it fails. Change the lamp. If the lamp is off, then the ballast will become malfunction. |
| Lamp LED | Off | Solid | |
| Temp LED | Off | Solid | |
| Power LED | Blue | Flash (Full brightness) | The projector is shutting and the fan motor is cooling the lamp for shutdown. Do not unplug the power cord or turn the power off before the Lamp LED changes to flashing. The fan motor will turn off when the lamp has cooled. |
| Lamp LED | Red | Solid | |
| Temp LED | Red | Solid | |
| Power LED | Blue | Solid (Full brightness) | Temperature is too high. The lamp will turn off. The fan motor is cooling the lamp. |
| Lamp LED | Red | Flash | |
| Temp LED | Red | Off | |
| Power LED | Off | Off | The lamp ignition failed. If temperature is too high, the fans will cool the lamp. |
| Lamp LED | Red | Solid | |
| Temp LED | Red | Solid | |

Compatibility Modes

Computer:

| Compatibility | Resolution | H-Sync [KHz] | V-Sync [Hz] |
|-------------------|--------------------|--------------|-------------|
| VGA | 640 x 480 | 24.6 | 50.0 |
| | | 31.5 | 59.9 |
| | | 37.9 | 72.8 |
| | | 37.5 | 75.0 |
| | | 43.3 | 85.0 |
| | 640 x 480 @ 120Hz | 61.9 | 119.5 |
| | 720 x 400 | 31.5 | 70.0 |
| 37.9 | | 85.0 | |
| SVGA | 800 x 600 | 31.0 | 50.0 |
| | | 35.2 | 56.0 |
| | | 37.9 | 60.3 |
| | | 48.1 | 72.0 |
| | | 46.9 | 75.0 |
| | | 53.7 | 85.1 |
| | 76.3 | 120.0 | |
| 800 x 600 @ 120Hz | 76.3 | 120.0 | |
| XGA | 1024 x 768 | 48.4 | 60.0 |
| | | 56.5 | 70.1 |
| | | 60.0 | 75.0 |
| | | 68.7 | 85.0 |
| | | 97.6 | 120.0 |
| | 1024 x 768 @ 120Hz | 97.6 | 120.0 |
| | 1152 x 864 | 67.5 | 75.0 |
| | 1280 x 960 | 60.0 | 60.0 |
| 85.9 | | 85.0 | |
| SXGA | 1280 x 1024 | 64.0 | 60.0 |
| | | 80.0 | 75.0 |
| | 1280 x 960 | 64.7 | 60.0 |
| | | 75.0 | 75.0 |
| | 1280 x 1024 | 64.0 | 60.0 |
| | | 80.0 | 75.0 |
| | 14460 x 1050 | 64.7 | 60.0 |
| 1600 x 1200 | 75.0 | 60.0 | |
| WXGA VESA 60Hz | 1280 x 800 | 49.7 | 59.8 |

Video:

| Signal | Horizontal Frequency (kHz) | Vertical Frequency (Hz) |
|---------------|-----------------------------------|--------------------------------|
| 1080i | 33.8 | 60.0 |
| 1080i | 28.1 | 50.0 |
| 1080p | 67.5 | 60.0 |
| 1080p | 56.3 | 50.0 |
| 720p | 45.0 | 60.0 |
| 720p | 37.5 | 50.0 |
| 576p | 31.3 | 50.0 |
| 576i | 15.8 | 50.0 |
| 480p | 31.5 | 60.0 |
| 480i | 15.8 | 60.0 |

Troubleshooting

Refer to the symptoms and measures listed below before sending the projector for repairs. If the problem persists, contact your local reseller or service center. Please refer to "LED Indicator Messages" as well.

Start-up problems

If no lights turn on:

- Be sure that the power cord is securely connected to the projector and the other end is plugged into an outlet with power.
- Press the power button again.
- Unplug the power cord and wait for a short while, then plug it in and press the power button again.

Image problems

If the searching source is displayed:

- Press the **SOURCE** button on the control panel or the **Source** button on the remote control one or more times to select another active input source.
- Be sure the external source is turned on and connected.
- For a computer connection, ensure your notebook computer's external video port is turned on. Refer to the computer manual.

If the image is out of focus:

- Be sure the lens cover is removed.
- While displaying the on-screen menu, adjust the focus ring. (The image size should not change; if it does, you are adjusting the zoom, not the focus.)
- Check the projection lens to see if it needs cleaning.

If the image is flickering or unstable for a computer connection:

- Press the **Auto** button on the remote control.
- Press the **MENU** button, go to **Computer Image** and adjust **Frequency** or **Tracking**.

Remote control problems

If the remote control does not operate:

- Be sure nothing is blocking the remote control receiver on the front of the projector. Use the remote control within the effective range.
- Aim the remote control at the screen or at the front or back of the projector.
- Move the remote control so it is more directly in front of or behind the projector and not as far to the side.

RS-232 Command and Configuration

Baud Rate:19200 Parity Bit:none

Data Bit:8 Stop Bit:1 Assign Port:COM1

| Name | Operation type | CRC | Header | Command | Response |
|---------------------|-------------------------|---------------------|---------|------------------------|-------------------------------|
| Power | ON | BE, EF, 10, 05, 00, | C6, FF, | 11, 11, 01, 00, 01, 00 | 06 |
| | OFF | BE, EF, 03, 06, 00, | DC, DB, | 69, 00, 00, 00, 00, 00 | 06 |
| Source | Computer 1 (Analog RGB) | BE, EF, 03, 19, 00, | 19, 29, | 01, 47, 02, CC, CC, 00 | 06 |
| | Computer 2 (Analog RGB) | BE, EF, 03, 19, 1E, | 90, 72, | 01, 47, 02, CC, CC, 00 | 06 |
| | S-Video | BE, EF, 03, 19, 00, | E8, 69, | 01, 47, 02, CC, CC, 00 | 06 |
| | Composite Video | BE, EF, 03, 19, 00, | 78, A8, | 01, 47, 02, CC, CC, 00 | 06 |
| | HDMI | BE, EF, 03, 19, 00, | DA, 2B, | 01, 47, 02, CC, CC, 00 | 06 |
| OSD | Menu | BE, EF, 02, 06, 00, | E9, D3, | 30, 00, 00, 00, 00, 00 | 06 |
| | Up | BE, EF, 02, 06, 00, | 6D, D2, | 34, 00, 00, 00, 00, 00 | 06 |
| | Down | BE, EF, 02, 06, 00, | 0B, D2, | 32, 00, 00, 00, 00, 00 | 06 |
| | Left | BE, EF, 02, 06, 00, | DA, D3, | 33, 00, 00, 00, 00, 00 | 06 |
| | Right | BE, EF, 02, 06, 00, | 38, D2, | 31, 00, 00, 00, 00, 00 | 06 |
| ECO | On | BE, EF, 03, 06, 00, | EF, DB, | 6A, 00, 00, 00, 00, 00 | 06 |
| | Off | BE, EF, 03, 06, 00, | 3E, DA, | 6B, 00, 00, 00, 00, 00 | 06 |
| Auto Source | On | BE, EF, 03, 06, 00, | 89, DB, | 6C, 00, 00, 00, 00, 00 | 06 |
| | Off | BE, EF, 03, 06, 00, | 58, DA, | 6D, 00, 00, 00, 00, 00 | 06 |
| Source | | BE, EF, 02, 06, 00, | 57, D0, | 2E, 00, 00, 00, 00, 00 | 06 |
| Auto-Sync | | BE, EF, 02, 06, 00, | 86, D1, | 2F, 00, 00, 00, 00, 00 | 06 |
| Blank Screen(Video) | | BE, EF, 02, 06, 00, | DF, DF, | 66, 00, 00, 00, 00, 00 | 06 |
| Keystone | Keystone | BE, EF, 02, 06, 00, | 3D, DE, | 64, 00, 00, 00, 00, 00 | 06 |
| | Up | BE, EF, 03, 06, 00, | 10, DB, | 65, 00, 00, 00, 00, 00 | 06 |
| | Down | BE, EF, 03, 06, 00, | 23, DB, | 66, 00, 00, 00, 00, 00 | 06 |
| Image | | BE, EF, 03, 06, 00, | F2, DA, | 67, 00, 00, 00, 00, 00 | 06 |
| Aspect Ratio | | BE, EF, 03, 06, 00, | 0D, DA, | 68, 00, 00, 00, 00, 00 | 06 |
| Factory Reset | | BE, EF, 03, 06, 00, | 6B, DA, | 6E, 00, 00, 00, 00, 00 | 06 |
| Lamp Hour | | BE, EF, 03, 06, 00, | BA, DB, | 6F, 00, 00, 00, 00, 00 | Lamp Hour |
| Firmware Version | | BE, EF, 03, 06, 00, | D5, D9, | 70, 00, 00, 00, 00, 00 | Version |
| System Status | | BE, EF, 03, 06, 00, | 04, D8, | 71, 00, 00, 00, 00, 00 | 03:Projector ON (Normal Mode) |

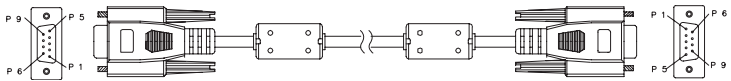

D-Sub 9 pin

| | |
|---|------|
| 1 | 1 CD |
| 2 | RXD |
| 3 | TXD |
| 4 | DTR |
| 5 | GND |
| 6 | DSR |
| 7 | RTS |
| 8 | CTS |
| 9 | RI |

Wire List

| C1 | COLOR | C2 |
|-------|--------|-------|
| 1 | Black | 1 |
| 2 | Brown | 2 |
| 3 | Red | 3 |
| 4 | Orange | 4 |
| 5 | Yellow | 5 |
| 6 | Green | 6 |
| 7 | Blue | 7 |
| 8 | Purple | 8 |
| 9 | White | 9 |
| SHELL | DW | SHELL |

IR Control Code



| Key | Format | Byte1 | Byte2 | Byte3 | Byte4 |
|--------------------------|--------|-------|-------|-------|-------|
| Power | NEC | 83 | F4 | 13 | 87 |
| Source | NEC | 83 | F4 | 13 | 02 |
| Up | NEC | 83 | F4 | 13 | 82 |
| Down | NEC | 83 | F4 | 13 | 85 |
| Left | NEC | 83 | F4 | 13 | 83 |
| Right | NEC | 83 | F4 | 13 | 81 |
| MENU | NEC | 83 | F4 | 13 | 84 |
| Auto | NEC | 83 | F4 | 13 | 64 |
| Mouse | NEC | 83 | F4 | 13 | 6B |
| ViewMatch | NEC | 83 | F4 | 13 | 63 |
| Freeze | NEC | 83 | F4 | 13 | 80 |
| Enter / Mouse Left | NEC | 83 | F4 | 13 | 8c |
| Exit / Mouse Right | NEC | 83 | F4 | 13 | 8d |
| KeyS+ | NEC | 83 | F4 | 13 | 86 |
| KeyS- | NEC | 83 | F4 | 13 | 8a |
| Digital Zoom+ | NEC | 83 | F4 | 13 | 68 |
| Digital Zoom- | NEC | 83 | F4 | 13 | 6a |
| Volume+ | NEC | 83 | F4 | 13 | 88 |
| Volume- | NEC | 83 | F4 | 13 | 89 |
| Mute | NEC | 83 | F4 | 13 | 8b |
| Blank | NEC | 83 | F4 | 13 | 8f |

Customer Support

For technical support or product service, see the table below or contact your reseller.

Note : You will need the product serial number.

| Country/Region | Web Site | T=Telephone F=Fax | E-mail |
|---|-----------------------------|---|---|
| Australia/New Zealand | www.viewsonic.com.au | AUS=1800 880 818 NZ=0800 008 822 | service@au.viewsonic.com |
| Canada | www.viewsonic.com | T (Toll-Free)= 1-866-463-4775 T (Toll)= 1-424-233-2533 F= 1-909-468-1202 | service.ca@viewsonic.com |
| Europe | www.viewsoniceurope.com | www.viewsoniceurope.com/uk/Support/Calldesk.htm | |
| Hong Kong | www.hk.viewsonic.com | T= 852 3102 2900 | service@hk.viewsonic.com |
| India | www.in.viewsonic.com | T= 1800 11 9999 | service@in.viewsonic.com |
| Ireland (Eire) | www.viewsoniceurope.com/uk/ | www.viewsoniceurope.com/uk/sup- port/call-desk/ | service_ie@viewsoniceurope.com |
| Korea | www.kr.viewsonic.com | T= 080 333 2131 | service@kr.viewsonic.com |
| Latin America (Argentina) | www.viewsonic.com/la/ | T= 0800 666 0194 | soporte@viewsonic.com |
| Latin America (Chile) | www.viewsonic.com/la/ | T= 800 440 303 | soporte@viewsonic.com |
| Latin America (Columbia) | www.viewsonic.com/la/ | T= 01 800 915 6588 | soporte@viewsonic.com |
| Latin America (Mexico) | www.viewsonic.com/la/ | T= 001 800 514 6518 | soporte@viewsonic.com |
| Renta y Datos, 29 SUR 721, COL. LA PAZ, 72160 PUEBLA, PUE. Tel: 01 222.891.55.77 CON 10 LINEAS Electroser, Av Reforma No. 403Gx39 y 41, 97000 Merida, Yucatan. Tel: 01.999.925.19.16 Other places please refer to http://www.viewsonic.com/la/soporte/index.htm#Mexico | | | |
| Latin America (Peru) | www.viewsonic.com/la/ | T= 0800 53458 | soporte@viewsonic.com |
| Macau | www.hk.viewsonic.com | T= 853 2870 0303 | service@hk.viewsonic.com |
| Middle East | ap.viewsonic.com/me/ | Contact your reseller | service@ap.viewsonic.com |
| Puerto Rico & Virgin Islands | www.viewsonic.com | T= 1-800-688-6688 (English) T= 1-866-379-1304 (Spanish) F= 1-909-468-1202 | service.us@viewsonic.com soporte@viewsonic.com |
| Singapore/Malaysia/Thailand | www.viewsonic.com.sg | T= 65 6461 6044 | service@sg.viewsonic.com |
| South Africa | ap.viewsonic.com/za/ | Contact your reseller | service@ap.viewsonic.com |
| United Kingdom | www.viewsoniceurope.com/uk/ | www.viewsoniceurope.com/uk/sup- port/call-desk/ | service_gb@viewsoniceurope.com |
| United States | www.viewsonic.com | T (Toll-Free)= 1-800-688-6688 T (Toll)= 1-424-233-2530 F= 1-909-468-1202 | service.us@viewsonic.com |

Limited Warranty

VIEWSONIC® PROJECTOR

What the warranty covers:

ViewSonic warrants its products to be free from defects in material and workmanship, under normal use, during the warranty period. If a product proves to be defective in material or workmanship during the warranty period, ViewSonic will, at its sole option, repair or replace the product with a like product. Replacement product or parts may include remanufactured or refurbished parts or components.

Limited Three (3) year General Warranty

Subject to the more limited one (1) year warranty set out below, North and South America: Three (3) years warranty for all parts excluding the lamp, three (3) years for labor, and one (1) year for the original lamp from the date of the first consumer purchase; Europe except Poland: Three (3) years warranty for all parts excluding the lamp, three (3) years for labor, and ninety (90) days for the original lamp from the date of the first consumer purchase; Poland: Two (2) years warranty for all parts excluding the lamp, two (2) years for labor, and ninety (90) days for the original lamp from the date of the first consumer purchase.

Limited One (1) year Heavy Usage Warranty:

Under heavy usage settings, where a projector's use includes more than four (4) hours average daily usage, North and South America: One (1) year warranty for all parts excluding the lamp, one (1) year for labor, and ninety (90) days for the original lamp from the date of the first consumer purchase; Europe: One (1) year warranty for all parts excluding the lamp, one (1) year for labor, and ninety (90) days for the original lamp from the date of the first consumer purchase.

Other regions or countries: Please check with your local dealer or local ViewSonic office for the warranty information.

Lamp warranty subject to terms and conditions, verification and approval. Applies to manufacturer's installed lamp only. All accessory lamps purchased separately are warranted for 90 days.

Who the warranty protects:

This warranty is valid only for the first consumer purchaser.

What the warranty does not cover:

1. Any product on which the serial number has been defaced, modified or removed.
2. Damage, deterioration, failure, or malfunction resulting from:
 - a. Accident, abuse, misuse, neglect, fire, water, lightning, or other acts of nature, improper maintenance, unauthorized product modification, or failure to follow instructions supplied with the product.
 - b. Operation outside of product specifications.
 - c. Operation of the product for other than the normal intended use or not under normal conditions.
 - d. Repair or attempted repair by anyone not authorized by ViewSonic.
 - e. Any damage of the product due to shipment.
 - f. Removal or installation of the product.
 - g. Causes external to the product, such as electric power fluctuations or failure.

- h. Use of supplies or parts not meeting ViewSonic's specifications.
 - i. Normal wear and tear.
 - j. Any other cause which does not relate to a product defect.
3. Removal, installation, and set-up service charges.

How to get service:

1. For information about receiving service under warranty, contact ViewSonic Customer Support (please refer to "Customer Support" page). You will need to provide your product's serial number.
2. To obtain warranted service, you will be required to provide (a) the original dated sales slip, (b) your name, (c) your address, (d) a description of the problem, and (e) the serial number of the product.
3. Take or ship the product freight prepaid in the original container to an authorized ViewSonic service center or ViewSonic.
4. For additional information or the name of the nearest ViewSonic service center, contact ViewSonic.

Limitation of implied warranties:

There are no warranties, express or implied, which extend beyond the description contained herein including the implied warranty of merchantability and fitness for a particular purpose.

Exclusion of damages:

ViewSonic's liability is limited to the cost of repair or replacement of the product. ViewSonic shall not be liable for:

1. Damage to other property caused by any defects in the product, damages based upon inconvenience, loss of use of the product, loss of time, loss of profits, loss of business opportunity, loss of goodwill, interference with business relationships, or other commercial loss, even if advised of the possibility of such damages.
2. Any other damages, whether incidental, consequential or otherwise.
3. Any claim against the customer by any other party.

Effect of state law:

This warranty gives you specific legal rights, and you may also have other rights which vary from state to state. Some states do not allow limitations on implied warranties and/or do not allow the exclusion of incidental or consequential damages, so the above limitations and exclusions may not apply to you.

Sales outside the U.S.A. and Canada:

For warranty information and service on ViewSonic products sold outside of the U.S.A. and Canada, contact ViewSonic or your local ViewSonic dealer.

The warranty period for this product in mainland China (Hong Kong, Macao and Taiwan Excluded) is subject to the terms and conditions of the Maintenance Guarantee Card.

For users in Europe and Russia, full details of warranty provided can be found in www.viewsoniceurope.com under Support/Warranty Information.

Mexico Limited Warranty

VIEWSONIC® PROJECTOR

What the warranty covers:

ViewSonic warrants its products to be free from defects in material and workmanship, under normal use, during the warranty period. If a product proves to be defective in material or workmanship during the warranty period, ViewSonic will, at its sole option, repair or replace the product with a like product. Replacement product or parts may include remanufactured or refurbished parts or components & accessories.

How long the warranty is effective:

3 years for all parts excluding the lamp, 3 years for labor, 1 year for the original lamp from the date of the first consumer purchase. Lamp warranty subject to terms and conditions, verification and approval. Applies to manufacturer's installed lamp only. All accessory lamps purchased separately are warranted for 90 days.

Who the warranty protects:

This warranty is valid only for the first consumer purchaser.

What the warranty does not cover:

1. Any product on which the serial number has been defaced, modified or removed.
2. Damage, deterioration or malfunction resulting from:
 - a. Accident, misuse, neglect, fire, water, lightning, or other acts of nature, unauthorized product modification, unauthorized attempted repair, or failure to follow instructions supplied with the product.
 - b. Any damage of the product due to shipment.
 - c. Causes external to the product, such as electrical power fluctuations or failure.
 - d. Use of supplies or parts not meeting ViewSonic's specifications.
 - e. Normal wear and tear.
 - f. Any other cause which does not relate to a product defect.
3. Any product exhibiting a condition commonly known as "image burn-in" which results when a static image is displayed on the product for an extended period of time.
4. Removal, installation, insurance, and set-up service charges.

How to get service:

For information about receiving service under warranty, contact ViewSonic Customer Support (Please refer to the attached Customer Support page). You will need to provide your product's serial number, so please record the product information in the space provided below on your purchase for your future use. Please retain your receipt of proof of purchase to support your warranty claim.

For Your Records

Product Name: _____ Model Number: _____
Document Number: _____ Serial Number: _____
Purchase Date: _____ Extended Warranty Purchase? _____ (Y/N)
If so, what date does warranty expire? _____

1. To obtain warranty service, you will be required to provide (a) the original dated sales slip, (b) your name, (c) your address, (d) a description of the problem, and (e) the serial number of the product.
2. Take or ship the product in the original container packaging to an authorized ViewSonic service center.
3. Round trip transportation costs for in-warranty products will be paid by ViewSonic.

Limitation of implied warranties:

There are no warranties, express or implied, which extend beyond the description contained herein including the implied warranty of merchantability and fitness for a particular purpose.

Exclusion of damages:

ViewSonic's liability is limited to the cost of repair or replacement of the product. ViewSonic shall not be liable for:

1. Damage to other property caused by any defects in the product, damages based upon inconvenience, loss of use of the product, loss of time, loss of profits, loss of business opportunity, loss of goodwill, interference with business relationships, or other commercial loss, even if advised of the possibility of such damages.
2. Any other damages, whether incidental, consequential or otherwise.
3. Any claim against the customer by any other party.
4. Repair or attempted repair by anyone not authorized by ViewSonic.

Contact Information for Sales & Authorized Service (Centro Autorizado de Servicio) within Mexico:**Name, address, of manufacturer and importers:**

México, Av. de la Palma #8 Piso 2 Despacho 203, Corporativo Interpalmas,
Col. San Fernando Huixquilucan, Estado de México
Tel: (55) 3605-1099 <http://www.viewsonic.com/la/soporte/index.htm>

NÚMERO GRATIS DE ASISTENCIA TÉCNICA PARA TODO MÉXICO: 001.866.823.2004**Hermosillo:**

Distribuciones y Servicios Computacionales SA de CV.
Calle Juárez 284 local 2
Col. Bugambillas C.P. 83140
Tel: 01-66-22-14-9005
E-Mail: disc2@hmo.megared.net.mx

Villahermosa:

Compumantenimientos Garantizados, S.A. de C.V.
AV. GREGORIO MENDEZ #1504
COL, FLORIDA C.P. 86040
Tel: 01 (993) 3 52 00 47 / 3522074 / 3 52 20 09
E-Mail: compumantenimientos@prodigy.net.mx

Puebla, Pue. (Matriz):

RENTA Y DATOS, S.A. DE C.V. Domicilio:
29 SUR 721 COL. LA PAZ
72160 PUEBLA, PUE.
Tel: 01(52).222.891.55.77 CON 10 LINEAS
E-Mail: datos@puebla.megared.net.mx

Veracruz, Ver.:

CONEXION Y DESARROLLO, S.A DE C.V. Av. Americas # 419
ENTRE PINZÓN Y ALVARADO
Fracc. Reforma C.P. 91919
Tel: 01-22-91-00-31-67
E-Mail: gacosta@qplus.com.mx

Chihuahua

Soluciones Globales en Computación
C. Magisterio # 3321 Col. Magisterial
Chihuahua, Chih.
Tel: 4136954
E-Mail: Cefeo@soluglobales.com

Cuernavaca

Compusupport de Cuernavaca SA de CV
Francisco Leyva # 178 Col. Miguel Hidalgo
C.P. 62040, Cuernavaca Morelos
Tel: 01 777 3180579 / 01 777 3124014
E-Mail: aquevedo@compusupportcva.com

Distrito Federal:

QPLUS, S.A. de C.V.
Av. Coyoacán 931
Col. Del Valle 03100, México, D.F.
Tel: 01(52)55-50-00-27-35
E-Mail : gacosta@qplus.com.mx

Guadalajara, Jal.:

SERVICRECE, S.A. de C.V.
Av. Niños Héroes # 2281
Col. Arcos Sur, Sector Juárez
44170, Guadalajara, Jalisco
Tel: 01(52)33-36-15-15-43
E-Mail: mmiranda@servicrece.com

Guerrero Acapulco

GS Computación (Grupo Sesicomp)
Progreso #6-A, Colo Centro
39300 Acapulco, Guerrero
Tel: 744-48-32627

Monterrey:

Global Product Services
Mar Caribe # 1987, Esquina con Golfo Pérsico
Fracc. Bernardo Reyes, CP 64280
Monterrey N.L. México
Tel: 8129-5103
E-Mail: aydeem@gpsl.com.mx

MÉRIDA:

ELECTROSER
Av Reforma No. 403Gx39 y 41
Mérida, Yucatán, México CP97000
Tel: (52) 999-925-1916
E-Mail: rrrb@sureste.com

Oaxaca, Oax.:

CENTRO DE DISTRIBUCION Y
SERVICIO, S.A. de C.V.
Murguía # 708 P.A., Col. Centro, 68000, Oaxaca
Tel: 01(52)95-15-15-22-22
Fax: 01(52)95-15-13-67-00
E-Mail: gpotai2001@hotmail.com

Tijuana:

STD
Av Ferrocarril Sonora #3780 L-C
Col 20 de Noviembre
Tijuana, Mexico

FOR USA SUPPORT:

ViewSonic Corporation
381 Brea Canyon Road, Walnut, CA. 91789 USA
Tel: 800-688-6688 (English); 866-323-8056 (Spanish);
Fax: 1-800-685-7276
E-Mail: <http://www.viewsonic.com>



ViewSonic®